



# **SUN CITY TEXAS DESIGN GUIDELINES**

***Approved by the Sun City Texas  
Community Association  
Board of Directors***

***August 22, 2019***

***This Design Guidelines supersede all previous versions.***

## REVISIONS

Modifications Committee writes the Design Guidelines (DG) which are approved by the Board of Directors in accordance with the Third Amended and Restated Declaration of Covenants, Conditions and Restrictions (CC&Rs) dated August 6, 2009 (Official Public Records, Williamson County, Document No.2009063124 ).

This document may be changed to serve the needs of the community in accordance with Article 2 of the DG and Article 5.3 of the Declaration (CC&Rs).

DATE	REVISION
October 14, 1996	Initial Release
September 14, 2000	Document Updated
November 8, 2002	Document Updated
March 24, 2005	Document Updated
September 27, 2007	Consolidated DG dated March 24, 2005, DG Revisions dated July 27, 2006 and Interpretive Guidelines (IG) after July 27, 2006 and before to September 27, 2007.
December 1, 2008	Consolidated DG dated September 27, 2007 & IG after September 27, 2007 & before December 1, 2008.
September 23, 2010	Consolidated DG dated December 1, 2008 and IG after December 1, 2008 and prior to September 23, 2010.
November 18, 2010	IG: Article (§) 2.7.2
May 26, 2011	IG: §10.1, §10.1.2, §4.3.6, §4.3.18a), §5.4.c), §5.10.6.b), 11.7.2, §4.5, §2.9 (#46) & §7.6
August 2, 2011	IG: §5.9, §2.9( #13)
November 17, 2011	IG: §12.2, §9.1(h), §9.8, §6.7 & §2.7.2 e)
February 13, 2012	IG: §1.7.4 & §5.10.8
May 24, 2012	IG: §4.2.2.d)
August 23, 2012	IG: §3.9.3, §3.9.6 & §3.13
February 28, 2013	IG: §4.1.2, §4.1.3, §4.1.3.1, §4.1.3.2., §4.1.3.3., §4.1.3.4., §4.2.1, §4.2.2., §4.2.4, Appendix A
April 6, 2013	Unanimous Approval by Board of Directors: §3.4.4.
November 21, 2013	IG: §1.2, §1.7.4, §2.1, §2.2, §2.3, §2.6.2, §2.7.1, §2.7.5, §2.10, §3.1, §3.4.3, §3.4.6, §3.5, §3.9.3, §3.9.4, §3.13, §4.3.11, §4.3.18, §4.3.19, §5.6, §5.7, §9.7.1., §13, & Appendix A
March 6, 2014	IG: §2.9, §3.9.1, §3.12, §4.5.3, §8.2, §9.5, Appendix F & Appendix G.
August 28, 2014	IG: §2.10, Figure 4-2, §4.3.1, §4.3.6, §4.3.9, §4.4.1, §4.5.3, §5.1.4, §6.2.2, §9.6.1, §11.2, §11.6 & Appendix G.
November 17, 2016	IG: §2.6.3, §2.6.4, § 2.6.5, §2.6.6, §2.6.7, §4.3.1, §4.3.2, §4.3.3, §4.3.57, § 6.8, §6.12, §11, Appendix A & Appendix C.
August 22, 2019	Complete Rewrite
August 27, 2020	§5.9.f); Appendix C

Executed and effective this 22<sup>nd</sup> day of August, 2019

DEL WEBB TEXAS LIMITED PARTNERSHIP,  
An Arizona Limited Partnership

By: Del Webb Southwest Co., an Arizona Corporation

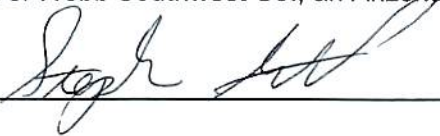
By:  \_\_\_\_\_

ADOPTED:  
SUN CITY TEXAS COMMUNITY ASSOCIATION, INC.  
Acting by and through its Board of Directors

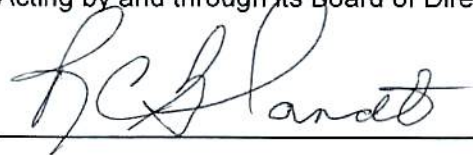
 \_\_\_\_\_

Bob Glandt

Title: Vice President

Revisions.....2

ARTICLE 1 – Design Guidelines & Modifications Committee Authority ..... 10

    1.1    *Design Guidelines (DG) Purpose & Enforcement* ..... 10

    1.2    *DG Use*..... 10

    1.3    *MC Authority* ..... 10

    1.4    *DG Violations* ..... 10

    1.5    *DG Violation Reporting* ..... 11

    1.6    *DG Changes & Amendments* ..... 11

    1.7    *MC Changes* ..... 11

ARTICLE 2 – Modification application procedures ..... 11

    2.1    *Home Owners’ Responsibilities* ..... 11

    2.2    *Modification Application Instructions*..... 12

    2.3    *Fee Purpose & Amount* ..... 12

    2.4    *Commencement of Work*..... 12

    2.5    *Approved Plan Execution* ..... 12

    2.6    *Failure to Comply*..... 12

    2.7    *Permits, Approvals & Licenses* ..... 12

    2.8    *Review & Approval Process* ..... 13

    2.9    *Non-Liability for Plans*..... 13

    2.10    *Errors that Authorize Non-Conforming Improvements* ..... 14

    2.11    *Disapproved Applications, Resubmission & Appeal Process* ..... 14

    2.12    *No-Paperwork List (NPL) & Prohibited Items and Structures List (PISL)*..... 14

ARTICLE 3 – Architectural Requirements ..... 14

    3.1    *Harmony of Design*..... 14

    3.2    *Allowed Materials* ..... 14

    3.3    *Roofs* ..... 14

    3.4    *Lot Drainage*..... 15

    3.5    *Freestanding Structures* ..... 16

    3.6    *Room Additions* ..... 16

    3.7    *Repair/Reconstruction Due to Destruction/Significant Damage* ..... 16

    3.8    *Doors & Windows* ..... 17

    3.9    *Knox Box® Program* ..... 17

    3.10    *Door or Garage Door or Window Replacement*..... 17

    3.11    *Emergency Repair of Doors or Windows* ..... 17

3.12	<i>Door Peepholes/Video Door Bells</i> .....	18
3.13	<i>Driveway Widening</i> .....	18
3.14	<i>ADA Accessibility</i> .....	18
3.15	<i>Exterior Painting &amp; Color Choices</i> .....	18
3.16	<i>Color Coating – Driveways, Sidewalks, Patios &amp; Porches</i> .....	18
ARTICLE 4 – Residential Landscaping .....		19
4.1	<i>Trinity Aquifer Recharge Zone</i> .....	19
4.2	<i>Home Owner Landscaping Standard</i> .....	19
4.3	<i>Initial Landscaping Plans</i> .....	19
4.4	<i>Existing Landscaping Changes</i> .....	20
4.5	<i>Impervious Materials Coverage</i> .....	20
4.6	<i>Xeriscape Landscaping Guidelines</i> .....	21
4.7	<i>Xeriscape Landscaping Coverage</i> .....	21
4.8	<i>Landscaping Lot Drainage</i> .....	22
4.9	<i>Irrigation/Sprinkler Systems</i> .....	22
4.10	<i>Drought-Tolerant &amp; Firewise Plant Use</i> .....	22
4.11	<i>Permitted Grasses</i> .....	22
4.12	<i>Lawn-Color Alteration</i> .....	23
4.13	<i>Ground-Mounted Equipment Screening</i> .....	23
4.14	<i>Hedges</i> .....	23
4.15	<i>Special Conditions Where Hedges May Be Acceptable</i> .....	23
4.16	<i>Side-Yard Access, Tree Wells &amp; Edging</i> .....	24
4.17	<i>Corner Lot Sight Triangles</i> .....	24
4.18	<i>Vegetable/Herb Gardens</i> .....	24
4.19	<i>Weed-Barrier Materials</i> .....	25
4.20	<i>Boundary Marking</i> .....	25
4.21	<i>Neighboring Property Rights</i> .....	25
4.22	<i>Tree Planting, Removal &amp; Replacement</i> .....	25
4.23	<i>Landscaping Near Retaining Walls</i> .....	25
4.24	<i>Wild-Animal Protection Fencing</i> .....	26
ARTICLE 5 – Accessory Features .....		27
5.1	<i>Pools, Spas, Hot Tubs &amp; Ponds</i> .....	27
5.2	<i>Fountains</i> .....	28
5.3	<i>Garden Hoses, Hose Hangers, Hose Reels &amp; Downspout Tubes</i> .....	28

5.4	<i>Bird Baths, Bird Houses, Shepherds Hooks &amp; Bird Feeders</i> .....	28
5.5	<i>Holiday Items</i> .....	28
5.6	<i>Artificial Flowers &amp; Foliage</i> .....	28
5.7	<i>Mailboxes</i> .....	29
5.8	<i>Lampposts</i> .....	29
5.9	<i>Flags &amp; Flag Mounts</i> .....	29
5.10	<i>Statues, Ornamentation &amp; Other Accessory Features</i> .....	31
ARTICLE 6 – Ancillary Equipment .....		32
6.1	<i>Ancillary Equipment – General Requirements</i> .....	32
6.2	<i>Attic Fans &amp; Skylights</i> .....	32
6.3	<i>Allowable Antennas – Satellite-Dish Antennas</i> .....	32
6.4	<i>TV, Amplified HDTV, Cellular Phone Booster/Repeater Antenna &amp; Broadband Internet Antennas</i> .....	33
6.5	<i>Antenna Installation – Amateur Radio</i> .....	33
6.6	<i>Solar Collection Systems</i> .....	34
6.7	<i>Rain Barrels (Domestic Rain Water Harvesting)</i> .....	35
6.8	<i>Lightning Arrestor Systems</i> .....	36
6.9	<i>Weather Stations</i> .....	36
6.10	<i>Rain Sensors</i> .....	37
6.11	<i>Residential Trash &amp; Recycling Containers</i> .....	37
6.12	<i>Construction/Landscaping Debris Boxes (“Dumpsters”)</i> .....	37
6.13	<i>Composting Guidelines</i> .....	37
6.14	<i>Residential Security Camera Installation and Use</i> .....	38
6.15	<i>Security Sirens</i> .....	38
ARTICLE 7 – Exterior Lighting .....		38
7.1	<i>Exterior Lighting – General</i> .....	38
7.2	<i>Duration &amp; Timing of Exterior Lighting</i> .....	38
7.3	<i>Maximum Total Brightness</i> .....	39
7.4	<i>Fixture Installation, Location &amp; Shielding</i> .....	39
7.5	<i>Fixture Maximum Number, Height, Spacing &amp; Output</i> .....	40
7.6	<i>Motion-Activated Lighting</i> .....	40
ARTICLE 8 – Barbecues, Fireplaces, Wood Stoves, Fire Pits & Similar items .....		40
8.1	<i>Non-Permanent Outdoor Fireplaces, Fire Pits &amp; Similar Items</i> .....	40
8.2	<i>Permanent Fireplace, Wood Stove, Fire Pits &amp; Similar Items</i> .....	40
8.3	<i>Barbecues &amp; Grills</i> .....	40

ARTICLE 9 – Fences .....	41
9.1    All Fences – General Characteristics & Requirements.....	41
9.2    Pool Fences .....	42
9.3    Decorative Fencing .....	42
9.4    Perimeter Fences.....	42
9.5    Patio Fences .....	43
9.6    Decorative Porch & Patio Gates.....	44
9.7    Neighborhood 38 (N38) – Perimeter Fences Characteristics .....	44
9.8    Neighborhood 38 (N38) – Perimeter Fence Requirements .....	45
9.9    Neighborhood 38 (N38) – Rear Patio Fence .....	45
ARTICLE 10 – Safety Rails, Safety Guardrails & Walls .....	45
10.1    Handrails & Safety Guard Rails .....	45
10.2    Safety Rails, Walls and Seat Benches — Homeowner Built .....	46
ARTICLE 11 – Decks, Patios, Porches & Courtyards .....	46
11.1    Enclosure of Patios, Porches & Courtyards – General .....	46
11.2    Rear Porch Enclosure Under the Original Roof or A Fully Integrated Hip/Gabled Roof Extension.....	47
11.3    Enclosure of Covered Patios.....	47
11.4    Patios, Decks or Raised Floor Surfaces .....	47
ARTICLE 12 – Architectural Screening & Shade Devices .....	48
12.1    Man-Made Awnings, Screens & Shades .....	48
12.2    Pergolas & Lattice Arbors.....	48
12.3    Trellises & Arbors – General Requirements.....	49
ARTICLE 13 – Maintenance Standards .....	50
13.1    Structural Maintenance .....	50
13.2    Landscaping Maintenance .....	50
13.3    Xeriscape Landscaping Maintenance .....	51
13.4    Metal Surface Maintenance .....	51
ARTICLE 14 – Landscaped Maintained Homes (LMH).....	51
14.1    Landscape Responsibility .....	51
14.2    LMH House Types .....	52
14.3    Garden Homes – N14A, N24A, N25 & N30 .....	52
14.4    Cottages (Monterey & Newport Models) – N24B1, N24B2 & N33 .....	52
14.5    Cottage Rear-Yard Privacy Lattice Dividers & Trellises .....	52
14.6    Annual Bedding Plants.....	52

14.7	<i>Decorative Concrete Fences – Front Yard</i> .....	52
14.8	<i>Coating Driveways, Walkways, Front Porches &amp; Rear Porches/Patios</i> .....	52
14.9	<i>Decorative Accessories &amp; Similar Items on Exterior Walls or in Flower Beds</i> .....	53
14.10	<i>Front Screen, Storm &amp; Designer Doors</i> .....	54
14.11	<i>Rear-Yard Fences</i> .....	54
14.12	<i>Fences – On-Patio, On-Porch &amp; Handrails</i> .....	55
14.13	<i>Irrigations/Sprinkler System Controls &amp; Soil Moisture Sensors</i> .....	55
14.14	<i>Lighting &amp; Lights</i> .....	55
14.15	<i>Mailboxes</i> .....	56
14.16	<i>Painting LMH Houses</i> .....	56
14.17	<i>Patio Additions</i> .....	56
14.18	<i>Pools, Spas, Ponds &amp; Hot Tubs</i> .....	57
14.19	<i>Roofing Repair or Replacement</i> .....	57
14.20	<i>Solar-Panel Installations</i> .....	57
14.21	<i>Wildlife Protection Fencing</i> .....	57
14.22	<i>Windows &amp; Window Pane Dividers/Grilles</i> .....	57
APPENDIX A – Definitions & Terminology .....		58
APPENDIX B – Commonly Used Acronyms .....		63
APPENDIX C – Recognized Holidays .....		64
APPENDIX D – Native Trees & Resources on Native & Adapted Plants .....		65
APPENDIX E - Recommended Plants .....		66
APPENDIX F – No-Paperwork List .....		71
APPENDIX G – Prohibited Items & Structure List .....		74



**EXAMPLES, DIAGRAMS & LISTS**

Example 4-1: Acceptable Screening Examples ..... 23  
Diagram 4-2: Modifications Prohibited Near Developer Installed Retaining Walls ..... 26  
List 6-1: Antenna Placement Acceptability List – Houses on Non-Corner Lots ..... 32  
List 6-2: Antenna Placement Acceptability List – Houses on Corner Lots ..... 33  
Diagram 6-3: Typical Lightning Arrestor Rods ..... 36  
Diagram 7-1: Shielded & Unshielded Lights ..... 39  
Diagram 9-1: Interior Lot Perimeter Fence ..... 43  
Diagram 9-2: Corner Lot Perimeter Fence ..... 43  
Diagram 9-3: Illustration Alternative Patio Fence Installations ..... 44  
Diagram 14-1: Typical LMH Garden Fence ..... 54  
Diagram 14-2: Typical LMH Cottage Fence ..... 54

**ARTICLE 1 – DESIGN GUIDELINES & MODIFICATIONS COMMITTEE AUTHORITY****1.1 DESIGN GUIDELINES (DG) PURPOSE & ENFORCEMENT**

- a) Sun City Texas is an active adult community designed to [BN1] blend into the visual character and natural surroundings of its site, minimize environmental impact, use reasonable water and energy conservation principles, and follow Firewise guidelines while offering a visually [BN2] pleasing community. The DG are established to maintain the standards by which the community may grow while preserving and enhancing these principles.
- b) As required in Section 5.1 of the Declaration of Covenants, Conditions, and Restrictions (CC&Rs)[CZ3] no exterior portion of any house [BN4] or lot, except for modifications that appear on the No-Paperwork List (NPL), may be remodeled, painted or otherwise altered without complying with the requirements set forth in the CC&Rs and these DG including prior submission and approval of an Application for Modification (application) when required.
- c) A home owner's failure to comply with the decision of the Modifications Committee (MC) is a violation of the home owner's obligations under both the CC&Rs and DG. Violations will result in enforcement actions by the Community Standards Department (CSD), Covenants Committee (CC) or the Board of Directors (BoD).

**1.2 DG USE**

- a) To provide an overall framework and a comprehensive set of standards and procedures to allow the community to develop in an orderly and consistent manner.
- b) [BN5] To assist Sun City Texas home owners to prepare applications.
- c) To assist the MC in considering applications.
- d) To provide the Sun City Texas Community Association (CA), CSD, and the CC the basis for their decisions regarding enforcement of community standards.[BN6]
- e) To establish criteria for the modification of the exterior of existing houses or the construction of new houses that have been severely damaged or destroyed.

**1.3 MC AUTHORITY**

- a) Article V of the CC&Rs sets forth provisions with respect to architectural and design review, including appointments of committees. MC has been established by the BoD to maintain the integrity of the architectural and design character that has been established by the [CZ7] developer and is maintained for the collective benefit of home owners.
- b) The MC reviews applications for alteration of any portion of a residential lot or the exterior portions of a house [CZ8] that are not [CZ9] on the NPL, and approves, returns for more information or disapproves the application based on the criteria set forth in the DG. To assist MC, the Architectural Advisory Group (AAG) and the Water Conservation Advisory Group (WCG) have been established as MC subcommittees.
- c) The MC, AAG, and WCG charters can be found on the CA website ([www.sctexas.org](http://www.sctexas.org)).

**1.4 DG VIOLATIONS**

Any alteration of any portion of a residential lot or to the exterior portions of a house [CZ10] without the approval of MC constitutes a violation of the CC&Rs and DG if done:

- a) Without the required application and MC approval.
- b) After MC has disapproved an application in whole or in part and a home owner executes the project despite the disapproval.
- c) In a manner that does not conform to the approved [BN11] application or in a manner that does not conform to the requirements of the NPL [BN12][CZ13].[CZ14]
- d) If the project has not been completed on or before 120-days after the application's approval or it is not completed on or before 60-days after work has begun.

## 1.5 DG VIOLATION REPORTING

Any resident may report a suspected violation of the DG by directly notifying the CSD. The identity of all residents reporting a suspected violation are held in strictest confidence under the rules of the CA Privacy Policy.

## 1.6 DG CHANGES & AMENDMENTS

- a) Changes or amendments to the DG are not retro-active. They only apply to applications reviewed after the date of an approved change. See [CZ15]Article 5.3, Paragraph 3 of the CC&Rs.
- b) Applications are reviewed and acted upon the DG in effect at the time of the application's submission.
- c) If an approved application permit expires 120-days after the approval date, a home owner is required to resubmit the expired application which will contain the changes or amendments approved since the original approval.
- d) The BoD may direct MC to amend the terms of the DG. The developer has the right to direct MC to amend or change the DG at any time, as long as, it owns any portion of the community or has the right to annex additional property in accordance with the CC&Rs. [BN16]Such amendments or changes will only apply to property on which the developer builds after the amendment or change is made.[CZ17]

## 1.7 MC CHANGES

MC plays a primary role in proposing amendments[CZ18] to the DG. An Interim Guideline (IG) is the procedural document through [CZ19]which MC proposes changes to the existing DG. MC must announce proposed changes [CZ20]in the *Communicator* email for a minimum of two weeks. Copies of the proposed changes/amendments must be posted on the CA website for resident comments for at least two weeks. MC must respond to all resident comments. After this review, the IG is sent to the CC for an enforceability evaluation. CC will provide MC with specific recommended changes to the IG. MC must respond to all CC recommendations. Once completed, the IG is submitted to the BoD for approval. Any changes/amendments to the DG must be BoD-approved and filed with Williamson County before they are implemented or enforced.

# ARTICLE 2 – MODIFICATION APPLICATION PROCEDURES

## 2.1 HOME OWNERS' RESPONSIBILITIES

- a) The City of Georgetown (CoG) or another jurisdictional authority may require a permit, depending on the proposed change, alteration or addition. It is the home owner's responsibility to ensure compliance with all permit requirements.
- b) The home owner is responsible for all activities involved in the modification of their house and property, regardless of who performs the actual work. Such activities include, but are not limited, to the following:
  1. The completion (blue or black ink) and submission of an original (not a fax, copy or scan) application bearing the original signature of the home owner.
  2. The home owner is responsible for the application details and the work performed regardless of who completes and submits the application.
  3. Execution of the application as approved with MC comments.
  4. The placement or storage of materials or equipment is prohibited on community streets without specific permitting by the appropriate CoG agency.
  5. Repair of any damage to hardscape or turf areas due to improper unloading or movement across any neighboring or CA property.
  6. General maintenance of the work site such as removal of trash, not creating hazards or nuisances beyond what is reasonably expected during construction.
  7. The home owner must ensure no debris is left on neighboring or CA properties after construction has been completed. If the contractor has left materials, the home owner is responsible for removal of those materials and the restoration of the site to its original condition

## 2.2 MODIFICATION APPLICATION INSTRUCTIONS

- a) The application forms are the Form B-1 for residential modifications and Form B-2 for exterior painting. They are available on the CA website ([www.sctexas.org](http://www.sctexas.org)) and in the CSD Customer Service Office (CSD CSO).
- b) Home owners must use the current version of the application form. Any application using the obsolete form will be returned to the home owner for re-submission.
- c) An original Form B-1 or Form B-2 application, along with any applicable fee, must be delivered to the CSD CSO, CA Member Services Office or mailed to CSD CSO, 2 Texas Drive, Georgetown, Texas, 78633.
- d) No more than three projects may be addressed in a Form B-1 application.

## 2.3 FEE PURPOSE & AMOUNT

The purpose of the non-refundable application fee is to offset the cost of administration, materials and services. The application fee is \$30. This is a one-time charge per house. If a home owner owns more than one house in the community, a \$30 application fee is due for each house when submitting the first application for each house.

## 2.4 COMMENCEMENT OF WORK

No work may commence on any project governed by the DG unless MC has approved an application and the required permit has been issued.

## 2.5 APPROVED PLAN EXECUTION

Modifications must be executed in accordance with the approved plan including any MC comments. Any changes to the approved plan require a resubmission of the application to the MC.

## 2.6 FAILURE TO COMPLY

Compliance with the approved plan is the responsibility of the home owner. If any work commences prior to MC's review and approval of application, the home owner will be liable for all costs necessary to bring the work into compliance with the CC&R, the DG and the removal of any non-compliant modifications. (See CC&Rs Article 5.8). Also, the home owner will be subject to CC and/or BoD sanctions.

## 2.7 PERMITS, APPROVALS & LICENSES

- a) Prior to submission of a request for a permit to be issued by the appropriate CoG department or other jurisdictional authority, the home owner must submit a B-1 Form or B-2 Form application to MC and obtain the committee's approval of any plans, changes, alterations or additions to the property or house. The CoG will not issue a permit without evidence of an MC-approved application and a CA-issued permit.
- b) Where a contractor is expected to secure all required permits on behalf of a home owner, it remains the home owner's responsibility to ensure that the appropriate permits are obtained.
- c) MC is not bound by any permit issued or approval granted by any other jurisdictional authority[CZ21][CZ22][CZ23].
- d) If the plans submitted by a home owner require a CoG or other jurisdictional authority permit, MC's approval of the project is not a guarantee that that agency will issue a permit. If the agency requires any changes to a project, those required changes must be resubmitted to MC for approval to ensure that the project remains in compliance with the DG.
- e) To the extent that any aspect of a project is governed by public law or by one of the community's Governing Documents (GD), the most restrictive standard will apply.

## 2.8 REVIEW & APPROVAL PROCESS

- a) Reviewing Body:
  1. MC is the sole reviewing body of Form B-1 and B-2 applications.

2. MC will review a properly completed application where changes to a lot or the exterior portion of a house are proposed.
  3. An application is normally reviewed without a hearing with the home owner. The review is based on the information contained within each application.
- b) Possible outcomes of the review process:
1. "APPROVED". Application is approved and a permit is issued.
  2. "APPROVED AS NOTED". Application is approved subject to compliance with a condition and a permit is issued. Compliance with the condition is mandatory.
  3. "RETURNED". Application is returned so that the home owner can provide missing critical information.
  4. "DISAPPROVED". When an application is disapproved, MC must cite the reason(s) for the disapproval and must include a specific DG reference as the basis for the disapproval.
  5. "VARIANCE". In cases where an application is not in compliance with DG requirements, the MC may recommend that the developer grant a variance from DG requirements. The developer is the sole authority to issue a variance. (See Article 2.9.(c)) If a variance is approved by the developer, a permit will be issued. If the developer does not approve a variance, the application is disapproved.

## **2.9 NON-LIABILITY FOR PLANS**

Article 5.7 of the CC&Rs contains a disclaimer of liability or responsibility of the MC for the approval of plans and specifications contained in any B-1 or B-2 Forms.

### a) Reviewing Timeline:

All reasonable efforts will be made to respond to the home owner within 30-days. In all cases, the response will be issued within 60-days of the submission of the application. Each application submitted or re-submitted will be treated separately.

### b) Commencement and Completion of Project Deadlines:

1. The MC-approved project must commence and be completed within 120-days from the date of the approval (See Section 5.4(c) of CC&Rs) and must be completed within 60-days after work has started. Failure to complete the approved project, in the time allowed, will require re-submission of the application to MC for an extension of the project's timeline. The length of an extension is at MC's discretion.
2. The period allowed for completion of the original landscaping of home owner maintained lots as provided for in Article 4.3.
3. Where the home owner fails to adhere to these timeframes, the matter is subject to enforcement by the CSD and CC.

c) Variances: A home owner may apply to the MC for a variance for any enhancement, products or changes that the developer makes to new houses that are not included in the current DG or where unique circumstances exist, such as: unusual topography, natural obstructions, hardship considerations, seemingly too strict or too precise a requirement in light of the particular circumstances under review, aesthetic and/or environmental considerations, or other MC considerations. (See Section 5.6 of the CC&Rs). Variance applications must:

1. Be compatible with the surrounding neighborhood.
2. Include detailed information, photographs, product description, installation location and other relevant information.

## **2.10 ERRORS THAT AUTHORIZE NON-CONFORMING IMPROVEMENTS**

If MC approves a non-conforming improvement or change through error, that approval is not a precedent for future applications.

## **2.11 DISAPPROVED APPLICATIONS, RESUBMISSION & APPEAL PROCESS**

Home owners have the right to appeal any application disapproved by MC:

Step 1 – The home owner may edit the disapproved application resolving the reason(s) the application was disapproved or provide additional information and submit a revised application.

A home owner may only have two resubmissions for the same project. A home owner may not appeal a "Returned" application.

**Step 2** – If disapproved, the home owner may request MC's reconsideration of the application and meet to discuss the disapproved application. At the meeting, MC will review the application after considering the additional information provided.

**Step 3** – If reconsideration results in another MC disapproval, the MC will provide a written explanation addressing all reason(s) for the disapproval and will cite appropriate references in the CC&Rs, DG, or GD. The home owner may appeal to the BoD. Home owner is required to submit their request, in written form (including email), to the Community Association's Executive Director, 2 Texas Drive, Georgetown, Texas 78633.

## **2.12 NO-PAPERWORK LIST (NPL) & PROHIBITED ITEMS AND STRUCTURES LIST (PISL)**

The purpose of the NPL is to delegate MC's authority to home owners for simple residential modifications and to eliminate some workload from the CSD CSO and MC. Home owners may use the NPL authority to make residential modifications, as long as, their implementation of that modification meets all DG requirements for that modification. If a home owner implements an NPL modification that does not meet all DG requirements, the home owner will be required to either modify the modification until it meets all requirements or submit an application stating their rationale for not meeting the DG requirements. See Appendix F for the NPL and Appendix G for the PISL.

## **ARTICLE 3 – ARCHITECTURAL REQUIREMENTS**

### **3.1 HARMONY OF DESIGN**

Any additions, alterations, repainting and renovations to the exterior of an existing house must conform to the design of the original house in style, detailing, materials and construction.

### **3.2 ALLOWED MATERIALS**

- a) All houses except Custom Homes: All materials used in maintenance, repair, additions and alterations must match those used in the original construction of the house as to color, composition, type and attachment method. The MC may allow substitute materials, including modified exterior paint color and roof shingles, if those materials are compatible with the community.
- b) Custom Homes: Masonry construction of either brick or stone is encouraged. Stucco is permitted.
- c) Lap siding material will be considered for houses without lap siding.
- d) Siding materials such plywood, Masonite or other sheet type sidings are prohibited.

### **3.3 ROOFS**

#### **3.3.1. Roof Pitch (Slope) Asphalt Shingles**

- a) Any alteration or improvement made to current existing roofs or any new or altered roof must have a minimum positive roof slope of between 2-inches and 4-inches per foot (2:12 or 4:12).
- b) Any new roof height must not exceed the existing roof height of the house.
- c) Any new roof height must not be lower than the existing eave height. Roof eave overhangs must match the house's existing eave overhang.
- d) A minimum vertical clearance of at least 8-feet must be maintained between the lot grade or finished surface and the nearest overhead obstruction.

#### **3.3.2. Roof Pitch (Slope) Laminated Roof Panels (Foam-Core, Metal Skin)**

Any installation of laminated roof panels and similar roofing systems must have a positive minimum roof slope of one-half-inch per foot (.5:12) or greater. Application must include manufacturer's design criteria and warranty provisions. Any roof slope less than one-half-inch per foot is prohibited.

#### **3.3.3. Roof Drainage**

All roofs/gutters/downspouts must drain onto the home owner's lot.

### 3.3.4. Roof Repair or Replacement

- a) Complete shingle replacement must be in the original color choices provided in series 100 through 400 houses. For approval of a shingle color other than an original color choice, a sample of the proposed roofing material, at least 4-inches by 4-inches in size, must accompany the application.
- b) Partial roof replacement must encompass the entire slope within which the damage exists. Partial roof replacement must use shingles that are identical to the existing roof.
- c) Roof patching using shingles that are identical to the existing roof is allowed in emergency situations to avoid damage to the house's interior. Prior approval by the MC is not required when immediate roof patching or partial roof replacement is necessary due to weather or other damage. An application is required after completion of the repair.
- d) The addition, removal or extension to existing ridge vents in the same color as the shingles and the replacement of static vents (turtle vents) with ridge vents does not require an application. A CoG building permit is required.
- e) With the exception of cottage homes, roof replacement is a NPL item, as long as, the shingles to be used are selected from the approved roof colors and are covered with a warranty that is equivalent to, or better than, the warranty for the existing shingles. Samples of the approved shingle colors are available on the CA website ([www.sctexas.org](http://www.sctexas.org)) and in the CSD CSO. A CoG building permit is required.
- f) For all houses, except Custom Homes, when repairing or replacing damaged shingle roofing, new shingles must have a warranty that is equivalent to, or better than, the warranty of the existing shingles on the house. Samples of the color choices are available on the CA website ([www.sctexas.org](http://www.sctexas.org)) and in the CSD CSO. |

### [CZ24]3.3.5. Roofing Material

All other roofing materials other than asphalt/fiberglass/composition shingles or laminated metal roof panels are prohibited.

## 3.4 LOT DRAINAGE

**3.4.1.** As provided for in the CC&Rs, when any additions, alterations, renovations or landscaping are made to an existing detached house, no home owner may alter the original drainage on a lot to increase the discharge of water onto an adjacent property without consent of:

- a) Home owner(s) of the affected property.
- b) CA Facilities Maintenance Department.
- c) The Property and Grounds Committee. [CZ25][CZ26]
- d) MC.
- e) Per CC&Rs Article 12.8: "Every Lot and the Common Area shall be burdened with easements for natural drainage of storm water runoff from other portions of the Properties; provided, no Person shall alter the natural drainage on any Lot to increase materially the drainage of storm water onto adjacent portions of the Properties without the consent of the owner(s) of the affected property, the Board and the Declarant. This easement shall not extend into Preserve Areas."

**3.4.2.** Home owners are responsible for all drainage issues or landscaping [CZ27] wall issues created as a result of any modifications.

**3.4.3.** The MC approval of an application does not relieve the home owner's responsibility for drainage.

## 3.5 FREESTANDING STRUCTURES

All freestanding structures such as storage sheds, dog houses and similar structures that are not attached to the house [CZ28] are prohibited. Freestanding arbors, trellises and screening structures for ground-mounted ancillary equipment are exempt from this requirement.

### 3.6 ROOM ADDITIONS

#### 3.6.1. Permitted Room Additions

- a) Room additions to existing houses are only permitted when space under the original roof is enclosed or when under an integrated roof extension.
- b) The exterior of any room addition must be finished in a manner that is consistent with the design, style and appearance of the original house, including walls, windows, eaves and any other feature.

#### 3.6.2. Set-back Lines

All additions to existing houses must be built within the set-back lines established and recorded for the lot.

#### 3.6.3. Design & Construction

The following conditions must be followed during the design and construction phases:

- a) All construction materials and equipment may be stored in front or behind the house during construction. Material or equipment stored on the sides of the house or on the street must be properly marked with reflective cones, stanchions, and/or safety warning tape. Street storage is limited to 5-days. CA or developer-owned property will not be used for the storage of equipment, materials or for disposal. Specific permitting by the appropriate CoG agency is required.
- b) Construction debris must be removed from the work site by the end of each day.
- c) The home owner is responsible for the CoG requirement that all structural, electrical and plumbing elements of work be certified by appropriate contractors/engineers.
- d) The AAG will determine the maximum size limitation to the addition based on such factors as set-back, neighbor's view of the addition, lot size, lot shape and overall appearance.
- e) Heating, ventilation and air conditioning (HVAC) window units are prohibited. Through-the-wall units, existing HVAC units and a new HVAC unit to replace or supplement the existing HVAC units are allowed.
- f) Exterior walls, roof, windows and door materials and finishes must match those on the existing house.

### 3.7 REPAIR/RECONSTRUCTION DUE TO DESTRUCTION/SIGNIFICANT DAMAGE

Home owners have several options to repair or reconstruct the house:

- a) The home owner must clear the lot of all debris within 1-month.
- b) Select one of the following courses of action:
  1. Repair or reconstruct the house and the landscaping consistent with the original construction within 12-months. No application is required.
  2. Repair or reconstruct the house and the landscaping consistent with the originally construction plus any or all previously approved modifications within 12-months. An application is required.
  3. Landscape and maintain the lot in a fully landscaped condition consistent with Article 4 within 4-months. An application is required.
- c) Any plan that deviates from the originally approved house plan requires an application.
  1. MC will consider how it fits within the architecture of the neighborhood and compliance with the DG.
  2. The AAG will review the application.
  3. Custom Homes: Builders are prohibited from building the same or similar model on adjoining lots or lots across the street from each other.
  4. The placement of any equipment, not otherwise provided for in the DG, requires the submittal of an application and MC approval.

### 3.8 DOORS & WINDOWS

#### 3.8.1. Doors, Vents & Pet Doors

- a) A pet door must open into an enclosed fenced-in area[CZ29].
- b) A pet door may not be installed in a roll-up garage door.
- c) A pet door may be installed in a side-entry door or rear door within an enclosed fenced area[CZ30].
- d) A vent may be installed in any side-entry door.
- e) Vents may be installed in a roll-up garage door:



1. Vents must be a “one piece” aluminum module type that consists of an integrated flange and horizontally louvered exterior plate with a 1/8-inch or denser internal screen and an inner flange.
2. Vents must fit within a single panel section of the door and must fit tightly to prevent the entry of moisture, debris or wildlife.
3. Two vents may be installed either in the top or bottom door panels.
4. A “blank panel” must be same color as the door and mounted flush on the panel.
5. Vent design must be of the same color and style as the existing door.

### **3.8.2. Security, Storm & Screen Doors**

The installation of custom security doors, storm doors and conventional screen doors must fulfill their intended function while maintaining the house’s design integrity.

- a) All security, storm and screen doors require an application.
- b) Storm doors and conventional screen doors must be either a full-view or two-pane combination type. A two-pane type often has an upper glass panel and a lower screen panel.
- c) The installation of retractable screen doors must be made of materials that complement the existing house color scheme. Retractable screen doors must be mounted directly to the door frame opening.
- d) The screen enclosure of the front entry area is prohibited.
- e) Screen colors must be dark bronze, black, charcoal, taupe or tan.
- f) Frame colors must match the color of the existing door frame or complement the color of the screen and color scheme of the house.

### **3.9 KNOX BOX® PROGRAM**

The CoG Fire Department has a secure residential access program entitled “Knox Box”®.

- a) The Knox Box® must be installed near the house’s front door.
- b) No other box locations will be considered.
- c) The Knox-Box® comes in black, bronze, cream or nickel (matte finish) and cannot be repainted any other color.

### **3.10 DOOR OR GARAGE DOOR OR WINDOW REPLACEMENT**

- a) An application is not required if the replacement windows are the same color and style as the original window. An application is required to change to a different color or style of window. The home owner must provide pictures, color, locations and dimensions with the application.
- b) Regardless of location, replacement doors must be of the similar design, material and color as the original door. An application is required if a change is made to the door design, material or color. The home owner must provide pictures, colors and illustrations.
- c) Replacement garage doors must be the similar style and painted the original door color. Panels with windows may be added. The home owner must provide pictures, colors and illustrations.

### **3.11 EMERGENCY REPAIR OF DOORS OR WINDOWS**

- a) A home owner may have temporary emergency repairs or replacement of windows and doors to provide for home security and weather protection.
- b) An application for a permanent solution is required within 60-days after the emergency repair.

### **3.12 DOOR PEEPHOLES/VIDEO DOOR BELLS**

- a) The installation of an outside monitoring device either a door peephole or a video doorbell near the front door of the residence.
- b) Acceptable colors for these devices are white, cream, brass, bronze, black or nickel.

### **3.13 DRIVEWAY WIDENING**

- a) The widening of a driveway must replicate developer-installed driveways.
- b) Additional areas adjacent to the driveway must not extend more than 2-feet on either side of the driveway.

- c) The width of a driveway at the curb must be no more than 30-feet.
- d) Any affected irrigation must be either capped or moved.

### 3.14 ADA ACCESSIBILITY

Changes to the exterior of the house and property that might be required to accommodate disabled residents must comply with the Americans with Disabilities Act (ADA) Standards for Accessible Design.

### 3.15 EXTERIOR PAINTING & COLOR CHOICES

- a) Use Form B-2 when requesting approval for changes in exterior paint color.
- b) Home owners may repaint their house in full or in part without the submission of a B-2 Form if they are not making any changes to the existing paint color scheme. A B-2 Form application is required if any change is to be made to the existing color scheme.
- c) The following conditions are the only limits to home owner's choice of colors:
  1. The use of colors designated for stucco, trim and accent colors are restricted to their designated areas. The MC will consider approving paint colors that are restricted to designated areas for other areas on brick homes.
  2. All references to paint and paint colors also apply to "stain" as it may be used to finish exterior surfaces.
  3. Semi-gloss must be used on the garage and front door. Flat or low-sheen paint must be used on all on the stucco. Flat or semi-gloss may be used elsewhere.
  4. 100 series houses must use at least two colors.
  5. 200, 300 and 400 series houses must use three colors.
  6. Gutters and gutter guards must be painted to match the trim color of the house. Downspouts must be painted to match primary color of the house.
  7. The MC will consider paint colors that are close to the Pulte/Del Webb color palette. If the color requested is not in the CSD CSO sample books, a color sample must be submitted with an application and compared to an approved paint color.

### 3.16 COLOR COATING – DRIVEWAYS, SIDEWALKS, PATIOS & PORCHES

Color coating of driveways, sidewalks, patios and porches floor surfaces are allowed:

- a) Any surface treatment must conform to the design of the original house and be compatible with neighborhood.
- b) The allowed colors are available on the CA website ([www.sctexas.org](http://www.sctexas.org)) and in the CSD CSO.
- c) Color coatings with texture to prevent slipping are allowed and encouraged.
- d) Coatings resulting in a stamped or template pattern or a definite multi-color appearance are prohibited [CZ31].
- e) Asphalt paving, gravel or any other loose material is prohibited.
- f) Only custom homes may use aggregate or stamped concrete.
- g) Sidewalk, patio and porch surfaces may have a stenciled pattern or simulated grout lines.
- h) The color of the overlay must be compatible with the color scheme of the house.
- i) Decorative borders [CZ32][CZ33][CZ34][CZ35] are permitted and must be at least 6-inches to 8-inches in width.
- j) Decorative borders may be overlaid with a stenciled pattern to simulate mortar-set brick or stone. [CZ36] [CZ37]

## ARTICLE 4 – RESIDENTIAL LANDSCAPING

### 4.1 TRINITY AQUIFER RECHARGE ZONE

- a) Sun City is located within the Trinity Aquifer Recharge Zone. It is important that the community protect this natural and limited resource by using smart water conservation, native and adapted Texas plants and xeriscape landscaping.
- b) Aquifer Rules found in Title 30 Texas Administrative Code Chapter 213 address activities that could pose a threat to water quality in the Trinity Aquifer including wells and springs fed by the aquifer and other sources such as surface streams and upland areas draining directly into the aquifer.

## 4.2 HOME OWNER LANDSCAPING STANDARD

Landscapes in Sun City are expected to conform to a standard of design and maintenance that is best described as “well-planted and well-maintained”. This is accomplished through:

- a) Hybrid Bermuda, Buffalo or Zoysia lawns or other ground covers comprising 50–70% of each lot excluding walkways, driveways, patios, ponds and other impervious material.
- b) Planting beds located across the front of the house. Typically planting beds and tree wells have a layer of hardwood mulch, decorative stone, rock or decomposed granite beneath the plantings.
- c) Trees, shrubs and lawns being well-maintained:
  1. Trees must be trimmed to remove dead or low branches less than 8-feet in height from finished grade.
  2. Shrubs must be trimmed as needed to maintain a natural shape.
  3. Lawns must be mowed and edged regularly and treated for weed control throughout the growing season.
- d) Year-round removal of leaves, weeds and debris.
- e) Xeriscape landscaping to conserve water through major irrigation system changes and the use of drought-tolerant plants. It must maintain a well-planted appearance and must not be confused with “desert” landscaping.

## 4.3 INITIAL LANDSCAPING PLANS

A home owner must submit a detailed initial landscape plan within 90-days after the date of closing. It is the individual home owner’s responsibility to completely landscape the entire lot within 120-days of plan approval.

- a) Full landscaping includes:
  1. A minimum of three planting beds.
  2. Lawn grass or properly designed xeriscape areas. (See Articles 4.6 & 4.7)
  3. Planting beds with living plants that are planted in the ground.
  4. HVAC must be screened from street view with a trellis or an evergreen plant. (See Example 4-1.)
  5. An irrigation system for the entire lot.
  6. Drip irrigation in all planting beds.
  7. Lawn and drip irrigation must be on separate valves.
- b) Non-Corner lots:
  1. Planting beds must be located across the entire front of the house.
  2. One side-yard planting bed.
  3. One rear-yard planting bed.
  4. Additional planting beds are optional, space permitting.
- c) Corner lots:
  1. One planting bed must be located across the entire front of the house.
  2. One side-yard planting bed facing the side street.
  3. If the corner lot has less than 7-feet between a developer-installed wall/fence and the house, then a side-yard planting bed facing the side street, is not required. If greater than 7-feet, a planting bed is required.
  4. One rear-yard planting bed.
  5. Additional beds are optional, space permitting.
- d) Narrow Lots: Lots having less than 7-feet from the exterior surface of the house to the side property line are not required to have a side planting bed. However, home owners have the option of either installing inert material, turf grass, ground cover or shrubs in the area. If the area is planted, proper irrigation is required for the area. In all cases, the air conditioning unit must be properly screened. See Example 4-1.
- e) All beds must be adjacent to the house’s foundation with the exception of stand-alone beds. See Article 4.3.g. Plants, at maturity, must be at least 6-inches to 12-inches away from the foundation to meet the recommended Firewise guidelines.
- f) If the home owner plans to install a new rear patio or to extend an existing patio within 12-months, a planting bed next to the foundation can be delayed until the new or extended patio is installed but must be within the 12-month timeframe after closing on the house.

- g) Stand-alone beds in the front or rear yards away from the house's foundation must have a fully landscaped appearance. (See Article 4.3.i.)
- h) It is recommended that all plants be drought-tolerant, native or adapted Texas plants and meet Firewise guidelines.
- i) Each landscape area must be planted and maintained with a minimum of 3, 3-gallon or 5, 1-gallon plants for every 100-square feet of planting bed area where a mature tree is not part of the planting bed.
- j) Height and type of planting beds must not create an unsightly effect or drainage problem for adjoining neighbors' properties.
- k) Requirements for creating planting beds around a mature tree (19-inches in circumference measured 1-foot from the ground and a 20-foot diameter canopy):
  1. Care must be taken to not disturb the tree's roots as many trees are sensitive to major soil disturbances.
  2. Planting beds measuring between 80-square feet and 100-square feet must have 2, 1-gallon or larger plants.
  3. For every additional 20-square feet added to a planting bed, 1, 1-gallon or larger plant must be added.

#### **4.4 EXISTING LANDSCAPING CHANGES**

Unless the landscaping change meets the requirements of the NPL, the home owner must submit an application giving the following details:

- a) A scaled drawing of the landscape plan.
- b) Location of lot boundaries, the house, driveways, walkways, patios and any other hardscape features and the location and dimensions of all planting beds.
- c) The names of all plants (See Appendix E) currently installed (if known) or to be added, the initial size of the plant, whether or not the plant is evergreen and the location and spacing of all plants.
- d) Materials to be used for planting bed borders, type of non-plant material to be used in beds such as hardwood mulch, decorative stone, rock or decomposed granite.
- e) All calculations for percentages of plants, lawn grasses, hardwood mulch, pine bark mulch and inert material coverage. Drought-tolerant plants and Firewise plants are encouraged.
- f) If the irrigation system is to be altered as part of a landscaping modification, the application must include a detailed description and drawing showing the scope of such changes. (See Article 4.9.)
- g) Type of landscaping edging used: limestone block, metal edging, paving blocks or formed concrete.
- h) Height and type of flower beds must not create an unsightly effect or a drainage problem where neighboring properties adjoin.

#### **4.5 IMPERVIOUS MATERIALS COVERAGE**

- a) Impervious Materials Coverage (IMC) is defined as any ground cover that does not permit the flow of water into the ground.
- b) IMC examples for residential lots are:
  1. Any building foundation, pad, driveway, concrete pathway, courtyard or patio.
  2. Any pond, pool or other water-retaining structure.
  3. Any other installed feature or structure over a compacted substrate.
  4. Further description of "impervious cover" can be found in Appendix A.
- c) The maximum IMC must not be more than 65% of any individual residential lot.

#### **4.6 XERISCAPE LANDSCAPING GUIDELINES**

Xeriscaping is the process of landscaping or gardening that reduces or eliminates the need for supplemental water from irrigation. Xeriscape landscaping plans must:

- a) Conform to the plants coverage and inert material limits stated in Article 4.7.2. (b).
- b) Height and type of flower and rock beds must not create an unsightly effect or a drainage problem for adjoining neighbors' properties.
- c) Show changes to the irrigation system.

**4.6.1. Three types of Color/Texture/Planting (CTP) Areas:**

- a) Planted areas must have 3, 3-gallon or 5, 1-gallon plants for every 100-square feet of bedding area.
- b) Inert areas must not exceed 45% maximum coverage.
- c) Turf areas must be covered completely by turf grass and/or living ground cover.

**4.6.2. Xeriscape areas must:**

- a) Be designed with multiple CTP areas which are areas of plantings, turf, living ground cover, hardwood/pine bark mulch and/or inert bedding material. Color and texture of the planted areas and inert areas are required aspects of a xeriscape design.
- b) Not have extensive areas of “desert” or “barren” appearance.
- c) Have MC approval. The application must include:
  1. Plants: names and sizes.
  2. Hardwood/pine bark mulch: types, sizes and colors.
  3. Rock/stone/decomposed granite: type and color.
  4. Calculations showing percent of inert material, hardwood/pine bark mulch, lawn grasses, and planting beds.
  5. Irrigation changes.

**4.6.3 Front-Yard Plan:**

- a) One CTP area with inert material and plants with the density and spacing required in 4.6.1. must occupy the balance of the front yard excluding impervious areas (driveway, walkways, and patios etc.) and the required 25% turf area.
- b) Areas with plants, ground cover and turf must comprise 55% of the front yard.
- c) It is recommended that 75% of all plants be drought-tolerant and Firewise plants.
- d) See Appendix E for a list of drought-tolerant and Firewise plants.

**4.6.4 Rear Yard Plan:**

- a) One CTP area with inert material and plants with the density and spacing required in Article 4.6.1. must occupy the balance of the rear yard excluding impervious areas (driveway, walkways, and patios etc.) and the required 25% turf area.
- b) Areas with plants, ground cover and turf must comprise 55% of the rear yard.
- c) It is recommended that 75% of all plants be drought-tolerant and Firewise plants.
- d) See Appendix E for a list of drought-tolerant and Firewise plants.
- e) The balance of the rear yard may be any combination of CTP areas or traditional landscaping.

**4.6.5 Side Yards:** The three types of CTP areas may be installed in side yards if space permits. Adequate space must be considered for required irrigation and property maintenance. Lots having less than 7-feet from the wall of the house to the side property line are not required to have a side planting bed. However, home owners have the option of either installing inert material, turf grass, ground cover or shrubs in the area. If the area is planted, proper irrigation is required for the area. In all cases, the air conditioning unit must be properly screened. See Example 4-1.

**4.7 XERISCAPE LANDSCAPING COVERAGE****4.7.1. Inert (Non-Living) Materials Coverage Percentage:**

- a) When inert material is used over large areas of the front and side yards, a variety of inert material colors and textures separated by approved edging must be used to form an “area” design.
- b) Such areas are either planted areas or they are inert areas to which the following inert area guidelines apply:
  1. Except for walking paths, no area of inert material (rock, stone or decomposed granite) without plant life may be greater than 100-square feet.
  2. Areas exceeding 100-square feet of inert material (rock, stone or decomposed granite) are considered an Inert Area and must be planted in accordance with Article 4.6.1.
- c) Prohibited Materials are:
  1. Ground or pulverized rubber mulch.
  2. Colored mulches other than black, brown or red dyed mulches.
  3. Highly reflective rock or bright white rock.
  4. Crushed glass or metal pieces/shavings.

5. Artificially colored rock.
6. Pine straw (pine needles), hay or straw.
7. Grass clippings and other landscaping waste materials.
8. Dead leaves and twigs.

**4.7.2. Preferred Landscaping Materials are:**

- a) Hardwood or pine bark mulch, rock and/or naturally pigmented stone and decomposed granite.
- b) Percentages of xeriscape landscaping coverage for front, side and rear yards:
  1. Plant material: 30% minimum.
  2. Turf grass or living ground cover: 25% minimum.
  3. Inert material: 45% maximum.
  4. Drought tolerant/Firewise plants: 75% minimum.
  5. Impervious Material: 65% maximum of the lot.

**4.7.3.** Ground covering and landscaping material used to spell out names, nicknames, names of states, athletic teams, slogans, states, emblems, geometric patterns or for any other form of communication is prohibited.

#### **4.8 LANDSCAPING LOT DRAINAGE**

Home owners are responsible for all lot drainage and retaining wall issues related to landscaping and residential modifications. (See Article 3.4)

#### **4.9 IRRIGATION/SPRINKLER SYSTEMS**

- a) The Texas Commission on Environmental Quality (TCEQ) in Title 30 Texas Administrative Code, Chapter 344 requires that only a TCEQ licensed irrigator, a licensed plumber, a registered landscape architect or the home owner may modify their residential irrigation system.
- b) The home owner is encouraged to use water-saving landscape measures such as efficient irrigation systems (ex., rotor spray nozzles in turf areas and drip systems in planting beds), efficient irrigation practices, a properly maintained irrigation system, proper mulching and low-water-use native and adapted plants.

#### **4.10 DROUGHT-TOLERANT & FIREWISE PLANT USE**

The use of native or adapted drought-tolerant plants and Firewise plants are recommended for all landscaping. The use of plants that have low oil content, open loose branching, are drought resistant, hold high moisture content in their foliage, are easy to maintain and require low water use are Firewise recommended.

Sun City Texas has been certified a “Firewise” community. The CA and each of its home owner members share the responsibility for maintenance of our properties in compliance with the standards that Firewise represents. For additional information on the community’s Firewise program go to the CA website ([www.sctexas.org](http://www.sctexas.org)).

#### **4.11 PERMITTED GRASSES**

- a) Permitted lawn grasses are Bermuda Hybrids, Buffalo Hybrids, and Zoysia Hybrids.
- b) Common Bermuda and St. Augustine grasses are prohibited due to their highly invasive nature.
- c) Lawns may be over-seeded in the fall with annual or perennial rye grass to maintain an attractive appearance.

#### **4.12 LAWN-COLOR ALTERATION**

The natural change of lawn color which occurs due to seasonal change such as drought or excessive moisture should be expected and appears throughout the community. The alteration of natural lawn color through the application of any dye, paint or other coloring agent is prohibited.

#### **4.13 GROUND-MOUNTED EQUIPMENT SCREENING**

- a) “Street view” means the view from the curb to anywhere within the boundaries of the property.

- b) All equipment must be screened from any street view. No more than 30% of the equipment may be visible through an approved screening structure or plants. Plants used for screening equipment must be an evergreen plant that will be at least 48-inches tall at maturity. (See Example 4-1.)
- c) For corner lots, equipment located on the street side must be screened with no more than 30% of the equipment visible through the screen from front and side view. Such screening must be plant material or a structure approved by the MC, the design, materials and color must be compatible with the design of the residence.
- d) White structures are prohibited.
- e) A screening structure must not be higher than 4-feet.
- f) Sufficient clearance between the screening structure and/or plant material and the equipment is required for adequate air circulation and must not encroach or trespass on a neighboring lot or CA property.
- g) Any other use of the approved screening structure for storing tools, materials, trash or recycling containers or similar items is prohibited.

**Example 4-1: Acceptable Screening Examples**



#### **4.14 HEDGES**

A hedge is defined as a continuous row of plantings, like a fence or boundary, formed by a dense row of shrubs or trees that are kept with their lower branches intact.

- a) Plantings must allow views to be preserved and must not:
  1. Impose a complete visual barrier between neighboring properties.
  2. Conflict with the open plan of the community.
  3. Create a continuous hedge, but plants may be used to provide a sense of privacy.
- b) The following are prohibited:
  1. Plants must not extend 50% or more of a property line.
  2. A continuous row of plants either in a straight-line or a nonlinear line with spaces less than 36-inches between plants at maturity.

#### **4.15 SPECIAL CONDITIONS WHERE HEDGES MAY BE ACCEPTABLE**

Lots on the edge of the community that are adjacent to major community streets or to CA recreation facilities such as pools, tennis courts, pickleball courts and similar facilities may submit an application to install an evergreen hedge.

#### **4.16 SIDE-YARD ACCESS, TREE WELLS & EDGING**

- a) The landscaping, construction or placement of tree wells and landscape beds in the side yards of houses must have a minimum of 30-inches clearance from the side property line on one side of the house to allow lawn mowers or other equipment without encroachment on the neighboring property.
- b) Outside edges of all tree wells must be at least 6-feet from the nearest tree.
- c) The installation of edging is to:
  1. Define planting beds, tree wells and separation from areas of differing turf.
  2. Contain areas covered with inert material.
- d) Maintain an effective visual border between turf grasses and defined planting beds:

1. The use of green, brown or black coated aluminum, steel or high-density polyvinyl chloride (PVC), limestone block edging or continuous concrete edgings are recommended.
2. The effect on lot drainage of any type of edging or its installation is subject to the provisions of Article 3.4.

#### **4.17 CORNER LOT SIGHT TRIANGLES**

- a) Trees must not be planted within the "sight triangle." The "sight triangle" consists of an area beginning at the intersection of the curbs and going 25-feet down each curb line and the connecting those points completes the triangle.
- b) Trees or tall plants (at any stage of maturity) that are taller than 3-feet or tree branches that are lower than 8-feet, where they obstruct motorists' views of on-coming traffic, are also prohibited in the sight triangle.
- c) Restrictions on planting in the "sight triangle" can be found in CoG Unified Development Code (UDC).

#### **4.18 VEGETABLE/HERB GARDENS**

- a) Home owners may have no more than two vegetable/herb gardens that must be:
  1. A maximum of 100-square feet for each vegetable/herb garden bed.
  2. Located in the portion of the rear yard behind the house and not visible from the front of the house.
  3. May be no longer than 20-feet in any one direction.
- b) The placement and structure of the vegetable/herb garden must comply with all provisions regarding drainage. (See Article 3.4.)
- c) Raised vegetable/herb garden beds must:
  1. Not be taller than 3-feet above the developer's finished grade.
  2. Use limestone block, metal edging, paving blocks or formed concrete.
  3. If the concrete block is covered with stucco, it must be painted to match the main color of the house.
  4. The use of plain concrete block, railroad ties or treated lumber is prohibited.
  5. Green or brown commercially designed garden beds made of high-density polyethylene may be used.
- d) Irrigation lines, if any, must be hidden from view.
- e) Vegetable/herb gardens must not create an unsightly visual appearance or drainage problem.
  1. Vegetable/herb gardens on golf course lots cannot be located within 20-feet of the rear property line.
  2. Vegetable/herb gardens on corner lots must be screened from the side street view.
- f) All vegetable/herb gardens must be maintained, at all times, to prevent an unsightly visual nuisance or a host for undesirable insects or other vermin.
  1. The home owner must keep the area free of weeds, woody growth, uncontrolled vines, dead or dying plants and debris.
  2. The use of supporting structures such as poles, cages and trellises must be colored green, brown, black or naturally oxidized, whether wood or metal.
  3. Streamers and reflective materials are prohibited.
- g) Fencing provisions are the same as Article 4.24.
- h) Vegetables/herbs may be interspersed in the rear-yard beds adjacent to the house.

#### **4.19 WEED-BARRIER MATERIALS**

- a) Solid (impermeable) plastic sheeting as a weed barrier or as a ground cover is prohibited.
- b) Landscape fabric must be:
  1. Woven, geo-textile fabric material type designed to allow the free flow of water, air and gases.
  2. Maintained with a minimum 2-inch layer of approved mulch or inert material.
- c) Installation of inert landscaping materials must be included in the 65% maximum coverage allowed.

#### **4.20 BOUNDARY MARKING**

The marking of property lines with concrete, dry-set or mortar-set limestone block, or similar materials is prohibited. Such boundary markers are allowed along the rear property line or when the adjacent property is CA-owned or controlled Level II, III or IV areas.



**4.21 NEIGHBORING PROPERTY RIGHTS**

- a) A home owner has the right to trim only the portion of a tree or shrub that extends across their property line from a neighboring property including CA property or CoG property. However, home owners are encouraged to coordinate any planned tree or shrub trimming with their neighbors.
- b) Home owners are not authorized to enter a neighbor's property, CA or CoG property to trim trees or shrubs.

**4.22 TREE PLANTING, REMOVAL & REPLACEMENT**

- a) Appendix D provides a list of trees suitable for the community's environment that may be planted on residential lots within the property line with the following exceptions:
  1. Trees on golf course lots must be planted so that the tree trunk is no closer than 20-feet from the rear property line. The MC may approve alternative planting schemes where they conclude that there will be no impact on the view from any other golf course lots.
  2. Corner lots: Trees must not be planted within the "sight triangle" (See Article 4.17).
  3. Interior lots: Trees must be planted at least 10-feet from a property line.
- b) Dead or terminally diseased trees must be removed as soon as such condition is recognized, taking appropriate protective measures to avoid the spread of disease.
  1. It is recommended that home owners seek the advice of a certified professional arborist when the health of a mature native tree is in question.
  2. An application is required, and the home owner must include pictures of the tree and a written recommendation from a certified professional arborist to remove any tree on the list in Appendix D.
- c) Healthy, naturally occurring trees, on the list of native trees in Appendix D, cannot be removed or cut down without submittal of an application.
- d) Healthy trees not on the list of native trees in Appendix D that are less than 19-inches in circumference, measured 12-inches from the ground, may be removed or cut down without submittal of an application.
- e) Removal of trees must include the removal of all debris and the remaining stump or cutting the stump to ground level.
- f) Trees removed because they are dead or diseased may be replaced at the home owner's expense. Trees may be replaced on a one-for-one basis. Replacement must be made within 2-feet of the removal site. All other provisions regarding tree type and placement, particularly on golf course lots, apply.
- g) Home owners are not required to have a tree in the front yard, but front yard trees are encouraged.

**4.23 LANDSCAPING NEAR RETAINING WALLS**

**4.23.1** A retaining wall is a structure designed to provide a barrier against movement of soil, rock or water. The three types of retaining walls are:

- a) Pavestone modular concrete block walls.
- b) Limestone walls constructed with or without mortar.
- c) Manufactured-concrete block with an integral locking capacity.

**4.23.2** Guidelines and restrictions for landscaping adjacent to developer-installed retaining walls:

- a) Diagram 4-2 describes the restrictions that apply to all landscaping near developer-installed retaining walls, whether the walls are on the property boundaries or not.
- b) Any damage to the subject retaining walls and/or surrounding property will be the responsibility of the home owner who has violated these restrictions.
- c) "No digging" means no digging into the ground or drilling into a developer-installed retaining wall. Any type of a landscaping modification to the area adjacent to or attached to developer-installed retaining wall is prohibited.

**4.23.3** "No digging" restriction does not apply to the installation of:

- a) Lawn grasses.
- b) Ground cover plantings.
- c) Inert material or hardwood/pine bark mulches.

- d) Fence posts that are installed 8-inches or more from the wall if installed in accordance with the provisions found elsewhere in the DG. (See Article 9.1.(g))
- e) See Appendix E for a list of recommended plants for planting near retaining walls.

**Diagram 4-2: Modifications Prohibited Adjacent to Developer-Installed Retaining Walls**

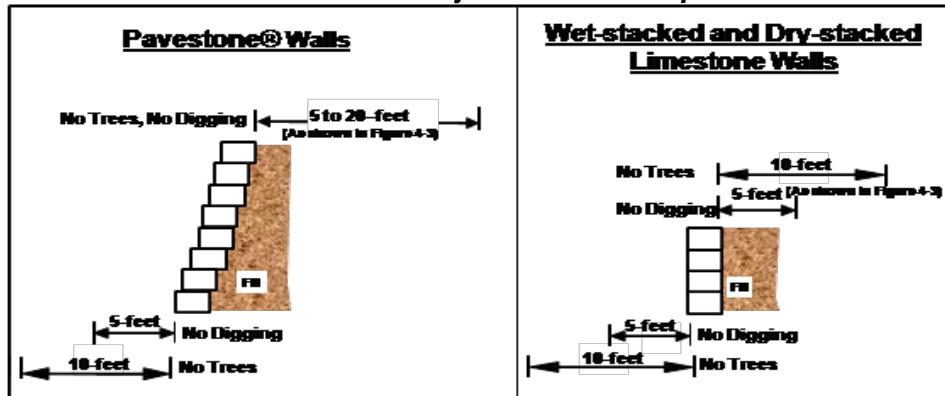

#### 4.24 WILD-ANIMAL PROTECTION FENCING

- a) Appearance and Maintenance:
  - 1. All wild-animal protection must be maintained in good order and appearance.
  - 2. The use of new material is preferred, however, the use of previously used or recycled materials that is consistent with the community's standards is permitted.
- b) Tree and Shrubbery Protection
  - 1. Wild-animal protection is permitted around trees and shrubbery.
  - 2. Materials around trees must be:
    - a. Made of plastic tubes or wire metal fencing manufactured/modified for the purpose of protecting a tree.
    - b. No more than 6-feet in height.
    - c. Green, brown, black or naturally oxidized in color and must be installed within 6-inches of the tree trunk.
  - 3. Mesh material used around shrubbery must be:
    - a. No more than 4-feet in height.
    - b. Green, brown, black or naturally oxidized.
    - c. Installed within 6-inches of the shrub drip-line.
  - 4. Supporting stakes for mesh materials must be:
    - a. Made of plastic material, plastic or vinyl coated metal.
    - b. Green, brown, black or naturally oxidized.
    - c. Not protrude more than 6-inches above the mesh.
  - 5. Wildlife netting is typically draped over the plant to be protected without supporting stakes. Netting must be a light weight material manufactured for the specific purpose of protecting plants from wildlife and must be minimally visible from the street.

### ARTICLE 5 – ACCESSORY FEATURES

#### 5.1 POOLS, SPAS, HOT TUBS & PONDS

All references to "pools, pool-spas and spas" include any similar water retention installation. The home owner is responsible for preventing the infestation of insect larva in all pools, spas, hot tubs, bird baths and ponds.

##### 5.1.1 PONDS

- a) Ponds must be installed in-ground.

- b) Two ponds per property are permitted with one pond in the front yard and one in the rear yard.
- c) Ponds located in the front yard must be located close to the front of the house and not exceed 3-feet in height above the developer-finished grade and meet fence safety requirements of the CoG.
- d) Ponds in the rear yard of the property must not exceed 5-feet in height above the developer-finished grade and meet fence safety requirements of the CoG.
- e) Ponds in the rear yard may encroach into the rear yard setback, but must be at least 3-feet from an adjacent property line.
- f) All ponds, whether considered a water feature with a waterfall or one that contains aquatic plants and fish, may be up to 3-feet deep and must have operational aeration/filtration systems to prevent stagnant water.
- g) Ponds cannot be drained onto any golf course, open space, storm drains, the street or any other property, whether common or residential. Ponds must be drained on the home owner's property or through the sanitary sewer system.
- h) Both the CoG and the MC consider a pond to be "impervious cover". The CoG prohibits any construction that causes the lot to have greater than 65% impervious cover.

### **5.1.2 POOLS, SPAS & HOT TUBS**

- a) A spa installation must include all screening required in Article 5.1.3. (See Example 4-1.)
- b) All pools must be installed in-ground.
- c) Above-ground pools are prohibited.
- d) Spas and hot tubs may be installed in-ground or above-ground.
- e) Above-ground spa and hot tub installations must not exceed 5-feet in height above the existing grade level or may be installed on a patio/deck approved by the MC if it complies with the specific height limitations applicable to that portion of the property.
- f) Pools, spas or hot tubs may encroach into the rear-yard setback and must be at least 3-feet from the adjacent property line. Pools, spas and hot tubs must not encroach into the side-yard set-backs in the rear yard.
- g) All pools with spas must be fenced in accordance with Article 9.2 for safety and as required by CoG requirements.
- h) Pool, spas and hot tub drains must meet all CoG requirements and ordinances. No pools, spas and hot tubs can be drained onto any golf course, open space or any other property, whether common or residential.
- i) All pools, spas and hot tubs must be installed in the rear yard of the house only.

### **5.1.3 POOL & SPA EQUIPMENT SCREENING**

- a) All screening, whether structural or landscape screening, must be included in the application.
- b) All equipment must be adequately screened with a lattice-type screening structure or landscaping that reasonably obscures the equipment when viewed from the street. (See Example 4-1.) The exception for corner lots is that the equipment facing the side street must be screened from both front and side view.
- c) Screening structures must match the primary color and materials of the house and must not be higher than 4-feet above the finished grade of the lot for lattice-type screening structures. If plant material is used to meet the objective of screening the equipment, it may be taller than 4-feet from the finished grade of the lot.
- d) The home owner should allow a minimum clearance of 2-feet around the equipment to provide for adequate air circulation, but must not encroach or trespass on to a neighboring lot.
- e) The area between the pool/spa equipment and the screening material must not be used for storage.

## **5.2 FOUNTAINS**

- a) Fountains may be installed in the front, side, rear or courtyard providing they do not detract from the overall landscape theme of the neighborhood.
- b) Fountains in the front yard must not be higher than 3-feet above the finished grade of the lot. If a fountain is installed against the front wall of the house or against the front of the foundation pad, it may be a maximum height of 4-feet above the finished grade of the lot.
- c) Rear-yard fountains must not be more than 5-feet above the developer-grade of the lot. Fountains built as an integral part of a raised patio must not exceed 5-feet in height above the patio's walking surface.
- d) Lightweight material, which may be moved by wind, is not acceptable.

- e) All fountains must be of a color, design and material that is compatible with the house and the overall architectural theme of the community.

### **5.3 GARDEN HOSES, HOSE HANGERS, HOSE REELS & DOWNSPOUT TUBES**

Wall or ground-mounted hose hangers and reels must be installed adjacent to a hose bib and must be mounted with the top of the hanging loop no more than 3-feet above the hard surface or finished grade. Downspout tubes must not be longer than 8-feet and must be green, brown or black.

### **5.4 BIRD BATHS, BIRD HOUSES, SHEPHERDS HOOKS & BIRD FEEDERS**

- a) Home owners may install one shepherds hook or pole-mounted bird feeder/bird house in the front of the house within 2-feet of the front exterior wall of the house or the original foundation of the house and must not exceed 6-feet in height. A shepherds hook or pole-mounted bird feeder/bird house not installed within 2-feet of the front exterior wall of the house or the original foundation of the house must not exceed 3-feet in height from the finished grade of the lot.
- b) Home owners may not install more than a total combination of three items: bird baths, bird houses, shepherds hooks or bird feeders in the rear yard. Other than tree-mounted bird houses, none of these items may be taller than 6-feet in height from the finished grade of the lot.
- c) On a golf course lot, no part of any item taller than 3-feet in height may be placed within 20-feet of the rear property line. The MC may approve modifications of greater height if they conclude that there will be no impact on the view from any other golf course lot.

### **5.5 HOLIDAY ITEMS**

- a) Holiday lighting as specified in Article 7.2.a. are allowed for the holidays listed in Appendix C.
- b) Holiday statues, ornaments, monuments, artifacts, lighting and other holiday decorative landscaping items on temporary display are allowed for 7-days prior to, during, and 7-days after a holiday. Holiday statues, ornaments, monuments, artifacts, lighting and other holiday decorative landscaping items on temporary display for Halloween, Thanksgiving, Christmas, Kwanza, and Hanukkah are allowed from October 1<sup>st</sup> through January 15th.

### **5.6 ARTIFICIAL FLOWERS & FOLIAGE**

- a) Up to three arrangements of artificial flowers or foliage that are appropriate to the season are permitted only on porches or patios and in courtyard areas. The use of these items elsewhere is prohibited.
- b) Home owners are responsible for keeping displays of artificial flowers and/or foliage in a presentable condition. Weather-worn and degraded materials are prohibited and must be removed or replaced.

### **5.7 MAILBOXES**

#### **5.7.1 DEVELOPER-INSTALLED MAILBOXES**

- a) Only mailboxes of the kind installed by the developer are permitted. Custom Home neighborhoods may have different mailboxes.
- b) The color, size, appearance and location of mailboxes must be preserved. White lettering with the house number must be affixed to the door of the mailbox.
- c) Replacement of mailboxes, due to damage or excessive wear, are the responsibility of the home owner. Replacement mailboxes must be of the same color, size, appearance and location as the original developer-installed mailbox.
- d) It is acceptable to place bird spikes on the top of mail boxes, as long as, these spikes do not interfere in any way with the function of the mailbox door or are located in a position where the mail carrier could be injured. If bird spikes are installed on a mailbox, they must be painted to match the mailbox's black color. Metal or plastic bird spikes are allowed.
- e) Holiday decorations may be temporarily attached to a mailbox and meet the guidelines in Articles 7.2.a, 7.3.b and Appendix C.

### 5.7.2 SECURE LOCKING MAILBOXES

Secure locking mailboxes designed with one or two retrieval doors for both front and rear access as long as:

- a) It meets US Postal Service standards and approval.
- b) It is properly post mounted in the location of the original developer-installed mailbox.
- c) It is similar in design to the developer-installed mailbox.
- d) The size does not exceed 11.3-inches wide by 11.5-inches high by 20-inches deep.
- e) It is made of black galvanized steel.
- f) The address numbers are white and the same original style font.

### 5.8 LAMPPOSTS

Lampposts of any kind are prohibited on residential properties.

### 5.9 FLAGS & FLAG MOUNTS

- a) House-Mounted Flags:
  1. One single-flag mount, two single-flag mounts or one two-flag mount are permitted if securely attached to the house at an approved location.
  2. Approved locations for the installation of flag mounts are:
    - a. For front-facing garage entries, flag mounts may be on either side of the garage, attached to the front or side of the garage door frame. The mount must be no less than 5-feet above the driveway surface and at a 90 degree angle to the attachment surface. For side-facing garage entries, flag poles must be parallel to the street.
    - b. For front-porch column or columns, mounts must be attached to the front or side of the column, no less than 5-feet above the porch surface and at a 90 degree angle to the column.
    - c. House-mounted flag poles must not extend more than 4-feet from the exterior wall of the house when measured from the horizontal.
- b) Ground-Mounted Flag Poles:
  1. One ground-mounted flagpole may be installed on residential lots subject to the following specifications:
    - a. Must be located no more than 5-feet to the rear of the rear-most plane of the house or no more than 5-feet in front of the front-most plane of the house, must be located on the right or left side of the lot as viewed from the street and must not be within 20-feet of the right or left side property line. The MC will consider alternate locations for lots that do not meet the 20-foot requirement.
    - b. Ground-mounted flagpoles must be installed vertically plumb.
    - c. Ground-mounted flagpoles must be permanently installed in a concrete base. The base must be screened from view with adequate landscaping.
  2. Native trees should not be removed for installation of a ground-mounted flagpole. However, if the removal of a native tree is necessary, a separate application to the MC is required.
  3. The top of an approved ground-mounted flagpole must not be higher than 20-feet or lower than 12-feet when measured from the developer-finished grade. Measurement includes any pole-top ornamentation.
  4. A ground-mounted flagpole with a height of 20-feet must be no less than 2 ½-inches in diameter at the butt (the point at which the pole meets the ground/concrete) and a top diameter between 1 ¾ and 2-inches. A ground-mounted flagpole with an exposed height of 12-feet to 19-feet, the butt and top diameter must be no less than 2-inches. The wall thickness of tubular material used for ground-mounted flagpoles must be no less than 0.125-inches.
  5. Ground-mounted flagpoles may be white, silver or bronze. Pole must be made of a corrosion/rot resistant material, such as aluminum or fiberglass.
  6. Flagpole-top ornamentation may only be an eagle or a ball and must be either the same color as the pole, be brass or have a brass-like finish.
  7. Chipping or peeling of paint, cracking or denting of pole material, bending, breaking, leaning or other loss of structural integrity of the ground-mounted flagpole or its foundation requires immediate remediation.
  8. Flagpole halyards must not make noise under any wind conditions.

9. Halyards must be securely fastened.
  10. Ground-mounted flagpoles and flags flown must be properly maintained.
- c) Flags Permitted to be on display:
1. No more than two flags may be on display at one time on one residential lot.
  2. Only the United States (US) flag, the Texas state flag or a US Armed Service flag may be flown on a ground-mounted flagpole.
  3. If the US flag is flown at the same time as another flag on a ground-mounted pole, the US flag must be flown in the top-most position.
  4. The size of the flags flown on a ground-mounted flagpole must be 3-feet top-to-bottom by 5-feet side-to-side and made of 2-ply polyester to provide for noise reduction due to flag flapping.
- d) For a detailed explanation of the rules for displaying the United States (US) flag and other government flags, refer to US Code, Title 4 Flag and Seal, Seat of Government and the States.
- e) Display of flags:
1. No display on inclement weather days unless it is an all-weather flag.
  2. If two flags are displayed simultaneously, on one pole or house surface, the US flag must be:
    - a. The highest flag on the pole.
    - b. On the left as viewed from the street if displayed on a house surface.
  3. Any pennant, banner, plaque, sign or other device that contains a rendition of the US flag is not permitted.
  4. No flag may be flown upside down or be allowed to touch the ground.
  5. No added mark, sign, insignia or design of any kind may be added to any approved flag.
  6. Neither the US flag nor Texas flag may be defaced or displayed with any advertising.
  7. Any of the 50 State Flags of the United States or its territories may be displayed at any time. Acceptable flags are those approved by the legislatures of the respective states and territories.
  8. US Armed Service Flags (Air Force, Army, Coast Guard, Marine Corps and Navy) may be displayed at any time.
  9. College, university or professional sport team flags may be displayed at any time. Illumination of these flags is prohibited.
  10. Flags or banners celebrating most holidays, religious or otherwise, may be flown during the period provided in Article 5.5 for holiday lighting and decorations. See Appendix C for a list of approved holidays.
- f) The US Flag may be displayed at any time. For nighttime display:
1. Proper lighting is required for nighttime display of the U.S. flag. See Article 7.2.
  2. Lighting used in the illumination of flags will be included in the calculation of the maximum allowable lighting emanating from the front of the house.
  3. In all cases, flag illumination is to be specifically dedicated to that purpose. No other lighting on the exterior of the home, including security flood or spot lighting, may be used for flag illumination.
- g) Display of Any Other Flags or Banners:
1. To display any flag or banner not listed above, the home owner must provide a photograph and description of the flag or banner to be displayed in an application and must receive approval from the MC before the flag or banner is displayed.
  2. A request to display the national flag of the country of origin of the home owner will be considered by the MC for proper display relative to the US flag, as described Article 5.9.(e) 2.a and b. The display of national flags of countries listed as State Sponsors of Terrorism by the U.S. Department of State is prohibited.
  3. When displaying a national flag at half-staff, a black streamer may be used to designate that the flag is intentionally positioned at half-staff.

## **5.10 STATUES, ORNAMENTATION & OTHER ACCESSORY FEATURES**

Statues, other yard ornaments, accessory features or artifacts placed in the front, side or back yard areas, except for permissible temporary holiday decorations, must meet the criteria below.

**5.10.1 FRONT-YARD RESTRICTIONS**

No statues, ornaments, monuments, artifacts or other landscape accessory features taller than 3-feet in height from the developer-finished grade of the lot may be placed in the front yard. On corner lots, no statues, ornaments, monuments, artifacts or other landscape accessory features may be taller than 3-feet on the side-street side of the house.

**5.10.2 OBJECTS ON THE DRIVEWAY OR ON/AROUND STORM DRAINS**

- a) One potted plant or one free-standing object that is not more than 3-feet in height may be placed at each side of the garage door and adjacent to the wall of house.
- b) Colors, patterns, size and placement of such objects on the driveway must be compatible with the primary color, materials and design of the house.
- c) Objects on the driveway must be free-standing and portable.
- d) Such items must be included in quantity limits set forth in Article 5.10.5.g.
- e) Placing items on or around the storm drains is prohibited if they interfere with storm drain maintenance.

**5.10.3 OBJECTS HANGING FROM TREES**

- a) No statues, ornaments, monuments and artifacts or other landscape accessories (except bird feeders, houses or baths) are permitted to be hung from trees in the front yard or side yard of corner lots.
- b) A maximum combined total of two bird feeders, houses or baths are permitted to be hung from trees in the front yard. For corner lots, a maximum combined total of three of these items are permitted between the front and street-facing side yard. In rear yards, a maximum combined total of three of these items are permitted.

**5.10.4 WALL ORNAMENTATION & OTHER ACCESSORY FEATURES**

- a) Decorative wall-mounted items to the front, rear and sides of the house are permitted.
- b) No more than two wall-mounted items may be viewable from any direction.
- c) No group of items may exceed 3-feet in overall dimension of height, width or diameter.
- d) If an application is submitted to mount an item exceeding these dimensions, the MC will consider the proportion of the wall space to the area required to mount the item or group of items when making its decision.
- e) Each item must be non-reflective and finished so as not to rust, fade or damage the house.

**5.10.5 REAR-YARD FREE-STANDING STATUES, MONUMENTS, ORNAMENTS & OTHER ACCESSORY FEATURES**

- a) Free-standing statues, monuments, ornaments and other accessories and artifacts located in the rear or side yards must not exceed 5-feet in height from the finished grade of the lot.
- b) A single item must not exceed 20-square feet in area.
- c) Swings, gliders and hammocks can be up to 6-feet in height from the finished grade.
- d) Golf Course Lots: No item higher than 3-feet at its tallest feature may be placed within 20-feet of the rear property line. The MC may approve applications for a greater height where they conclude that there will be no impact on the view of home owners from any other golf course lot.
- e) Items made of lightweight material are prohibited.
- f) Color, material and design must be compatible with the color and design scheme of the house.
- g) Ten items, visible from any viewpoint, is the maximum number of statues, monuments, ornaments, other accessory features and bird baths.

**ARTICLE 6 – ANCILLARY EQUIPMENT****6.1 ANCILLARY EQUIPMENT – GENERAL REQUIREMENTS**

- a) All ground-mounted equipment must be screened.
- b) Roof-mounted electric or solar-powered attic fans are allowed.
- c) Window air conditioners and fans are prohibited.
- d) Other roof-mounted equipment will be considered on a case-by-case basis.

- e) Exterior wall-mounted air conditioners and heat pumps for use in an enclosed patio or porch must meet the following requirements:
1. The wall-mounted unit must be installed in the rear or side of the enclosure.
  2. The bottom of the unit must not be higher than 12-inches from the interior floor surface as measured from the floor surface to the bottom of the unit.
  3. The exterior of the unit must be screened from view. (See Example 4-1)
  4. Placement and screening requirements for use of alternative technologies will be considered when the application is accompanied by manufacturer's literature.
- f) Sound-insulating material may be required for added equipment such as pool pumps and heaters. Added equipment must be installed in the same side yard as the air conditioning/condensing unit.

## 6.2 ATTIC FANS & SKYLIGHTS

### 6.2.1 ROOF-MOUNTED ATTIC FANS

- a) Electric: The standard location is on the rear portion of the roof and not visible from the street in front of the house. Other locations are possible. Electrical leads or connecting cables must run into the attic space and not across the roof. A CoG permit is required.
- b) Solar-Powered: Units may be located any place on the roof required in order to capture the needed amount of sun. Only units that parallel the roof's slope facing the street-side are permitted. A CoG permit is required.

### 6.2.2 SKYLIGHTS

- a) Skylight may be located any place on the roof. A CoG permit is required.
- b) Skylight shapes can be rectangular or tubular shaped, but must not contain internal lighting unless LED lighting is used and fully shielded from outside view.

## 6.3 ALLOWABLE ANTENNAS – SATELLITE-DISH ANTENNAS

Satellite-dish antennas with a diameter of one meter (39.37-inches) or less used to receive video (or other antennas whose installation and use is protected under Federal law or regulations) may be installed outside a house without prior approval from the MC, as long as, the antenna is installed at the location with the highest placement priority that provides a viable signal. See List 6-1 and 6-2. All exposed cables and wiring must be routed at right angles and securely fastened to the house.

### *List 6-1: Antenna Placement Acceptability List – Houses on Non-Corner Lots*

1	<b>REAR-YARD FASCIA.</b> Anywhere on the rear roofline fascia.
2	<b>LOWER REAR PORTION OF ROOF.</b> On the portion of the roof that slopes toward the rear of the lot within 15 feet of the roofline. Must be at least 15-feet from the front of the house.
3	<b>SIDE-YARD FASCIA (as far back as possible).</b> On the roofline fascia facing either side of the lot, except that the mounting location must be as close to the rear roofline as possible. Must be at least 15-feet from the front of the house.
4	<b>ROOF.</b> Any location on the roof of the home, as long as, the mounting location is not visible from the street in front of the house.
5	<b>GROUND MOUNTED &amp; SCREENED.</b> Ground-mounted antenna in an area that is not visible from a street and screened from view. (See Example 4-1.)
6	<b>ANY OTHER LOT LOCATION.</b> Any other location on the home or lot that is screened from view. (See Example 4-1.)

### *List 6-2: Antenna Placement Acceptability List – Houses on Corner Lots*

1	<b>REAR-YARD FASCIA.</b> Anywhere on the rear roofline fascia away from the side street.
---	--



2	<b>LOWER-REAR PORTION OF ROOF.</b> On the portion of the roof that slopes toward the rear of the lot within 15 feet of the roofline. Must be at least 15-feet from the front of the house.
3	<b>SIDE-YARD FASCIA (as far back as possible).</b> On the roofline fascia facing either side of the lot, except that the mounting location must be as close to the rear roofline as possible. Must be at least 15-feet from the front of the house.
4	<b>ROOF.</b> Any location on the roof of the house, as long as, the mounting location is not visible from either the front or side street.
5	<b>GROUND MOUNTED &amp; SCREENED.</b> Ground-mounted in an area that is not visible from a street and screened from view. (See Example 4-1.)
6	<b>ANY OTHER LOT LOCATION.</b> Any other location on the house or lot that is screened from view. (See Example 4-1.)

#### **6.4 TV, AMPLIFIED HDTV, CELLULAR PHONE BOOSTER/REPEATER ANTENNAS & BROADBAND INTERNET ANTENNAS**

These antennas may be located anywhere on the roof, as long as, the antenna is hidden as much as possible from the front view of the house while still permitting adequate signal strength.

#### **6.5 ANTENNA INSTALLATION – AMATEUR RADIO**

##### **6.5.1 GENERAL RADIO ANTENNA REQUIREMENTS**

- Certain antennas may be installed on the house or home owner's lot to facilitate the sending and/or receiving radio signals by residents that are federally licensed Amateur Radio Operators.
- Emissions from the antennas will be governed by the FCC Rules & Regulations.
- Antennas may be of the vertical or horizontal wire type or a combination of each.
- Temporary installations of Type 1, 2 and/or 3 antennas are allowed for a maximum of 30-days for testing.
- Only a maximum of two antennas may be installed.
- A copy of the home owner's FCC Amateur Radio Operator License must be on file with CSD.

##### **6.5.2 ALLOWED TYPES OF RADIO ANTENNAS**

- Type 1 – VHF/UHF Dual-Band Vertical Antenna:  
These antennas must not exceed 12-feet in height, 2-inches in diameter at their widest point in their taper and be mounted on the eaves, fascia or at the gutter edge of the house.
- Type 2 – HF Ground-Mounted Vertical Antenna:
  - These antennas must be ground-mounted and must not exceed 40-feet in height above the developer-finished grade.
  - Type 2 antenna are permitted only in the rear of the house and must be self-supporting [without guy wires]. If the antenna is part of a ground-mounted flag pole, flag pole guidelines apply.
  - Antenna may be constructed of metal, fiberglass or other suitable material.
  - The taper at the base must be of a size to support the antenna without guy wires.
- All leads, wires or other connections between the antenna and the exterior of the house must be enclosed in conduit or otherwise protected as required in building codes, routed at right angles and securely fastened to the house. If any leads, wires or other connections are enclosed in conduit, the conduit must be painted to match the primary color of the house. Home owners of brick houses must paint any exterior conduit to match trim color of the house.
- Type 3 – HF Horizontal Wire Antenna:
  - Wire antennas may be mounted along the ridge line of the roof from one side of the house to the other side of the house and no more than 18-inches from the roof surface. Wire antennas may also be mounted around the perimeter of the house under the eaves or fascia board.
  - Wire size must not exceed 12-gauge, be bare or coated with a dark color.

3. Associated mounting hardware and equipment (such as end-mounts, eye-bolts, turnbuckles, tensioning devices and insulators) must be made of rust and corrosion-resistant material and non-reflective color that will blend with the roofing or trim color of the house depending on where mounting is done.
4. Mounting must employ tensioning devices that minimize the catenary [sagging] effect and present horizontally strung wire parallel to the ridge line of the roof to the maximum degree possible.
5. The connecting wire from the antenna must enter the house at the closest feasible point to the antenna-mounting point.
6. In all cases, installation must not be a visual distraction or present a hazard.

#### **6.5.3. RADIO ANTENNA CONNECTIONS**

- a) The connecting wire (feed-line), from the antenna to the entry point into the house, must enter the house at either the closest point to a mounting point of the antenna or a point close to the mid-point of the antenna.
- b) House-to-house wiring for common use of antennas is allowed. Above ground wiring will only be approved through an application and by variance. Underground wiring is approved using the NPL. See Article 2.9c.
- c) Any grounding wires installed on the exterior of the house are to be treated in the same manner as specified for antenna wires.

#### **6.5.4. REMOVAL OF RADIO ANTENNAS**

- a) The party responsible for removing any radio antennas, associated mounting equipment and wiring from the house remains with the home owner who installed these items.
- b) Antennas and all associated equipment and wiring are to be removed within 30-days if the property is leased, sold or the licensed operator no longer resides in the house.

### **6.6 SOLAR COLLECTION SYSTEMS**

#### **6.6.1 ACCEPTABLE SOLAR-PANEL INSTALLATIONS**

- a) Solar collectors mounted on the roof of the house must have the top edge parallel to the roof ridgeline. The installation must not project above the roof ridge line.
- b) Any piping, tubing, conduit, junction boxes, combiner boxes, mounting feet or mounting rails associated with the solar collectors, that are on the roof, must be under the collector and not visible from the ground, or they must be painted to match or complement the color of the roofing material.
- c) Any piping, tubing, conduit, junction boxes, combiner boxes that are routed across the fascia or exterior wall of the house, must be painted to match the primary color of the house over which they are routed. Piping, tubing, conduit, junction boxes, combiner boxes or wiring that is silver, bronze or black will be considered for approval.
- d) Utility panels and leads or connecting cables that are silver, bronze, or black tones will be considered.
- e) A system with battery backup capability must have the battery bank installed in the garage and must include the required external ventilation.
- f) The system must be:
  1. Designed by a licensed solar contractor.
  2. Built from commercially available components.
  3. Installed by a licensed contractor.
  4. Conform to the current National Electric Code.
- g) Solar collectors will be considered for installation inside an approved fenced yard or patio. Such installations must meet the above conditions, plus they must be no higher than the height of the fence. These types of installations will be considered as a last-resort installation design because of specific conditions that preclude the installation on the house roof. Each situation will be reviewed individually for its specific circumstances and any approval granted will be done by variance.
- h) Solar collectors must be located to avoid glare and creating a nuisance for neighboring properties.

#### **6.6.2 TREE TRIMMING OR REMOVAL**

- a) Trimming trees located on the home owner's lot to facilitate the operation of solar-power generating equipment is allowed.

- b) Trimming trees not on the home owner's property is prohibited except for the tree trimming allowed in Article 4.21.
- c) Tree removal is discouraged.

## **6.7 RAIN BARRELS (DOMESTIC RAIN WATER HARVESTING)**

A rainwater harvesting system consists of the following components: catchments (roof), conveyance system (gutters, downspouts and piping), storage (rain barrel), filtration (debris-removal mechanism) and distribution system. An application is required for all rain barrels and domestic rain water harvesting systems.

- a) Rain barrels, including cement pads or risers, are limited to three groups of 1 or 2 barrels each (maximum six barrels per residential property) and must be located within 1-foot of the house in either the rear yard or in the side yard next to the rear corner of the house.
- b) A diagram showing where the rain barrels are to be located must be submitted with the application.
- c) Rain barrels must not be greater than 60-inches in height and 30-inches in diameter and no more than 180-gallon capacity.
- d) Water collection must be from downspouts and/or HVAC condensation only.
- e) The relocation or re-routing of downspouts solely for the purpose of rainwater collection is permitted. All modified gutters must be painted to match the rest of the house gutters.
- f) Only plastic, fiberglass or concrete barrels manufactured for rain water harvesting may be used. The re-use of whiskey, wine, trash or other types of barrels that are not specifically designed for rainwater harvesting are prohibited.
- g) Barrels and any associated mechanical equipment must be black or any color that matches the primary color of the house so that it does not stand out. Terra-cotta colored barrels made to look like clay pots or planters are acceptable.
- h) Barrels or any associated mechanical equipment which are installed in side yards must be screened from the street and neighbor's view by evergreen plants and/or latticework. See Example 4-1.
- i) Barrels must be placed on a concrete pad, landscaping pavers or other solid impervious material to avoid settling and tipping.
- j) Home owner must insure that any overflow of water will be handled in a manner consistent with the original drainage pattern of the property and is responsible for correcting any pooling of water or any impact to adjacent property. (See Article 3.4.1.)
- k) Home owner is responsible for preventing the infestation of insect larvae in the rain barrel system.

## **6.8 LIGHTNING ARRESTOR SYSTEMS**

### **6.8.1 ARRESTOR INSTALLATIONS**

- a) Lightning rods are generally composed of roof-mounted rods, heavy gauge connecting (grounding) cable, and surge protection apparatus in a metal utility box (wall-mounted) and grounding rod cable. The purpose of these rods and cable is to provide a safer mechanism for routing lightning electrical energy surges to the ground rather than having the surge pass through the house.
- b) Lightning arrestors must be connected to wires, other than lightning rod wires, that are routed on the outside of a house. The arrestor will divert electrical energy surges caused by lightning strikes to a grounding cable reducing possible damage to the house.

### **6.8.2. ARRESTOR RODS**

Arrestor rods should be mounted on the peak of the roof and connected to the surge arrestor with heavy gauge cable. The surge arrestor must be installed in a metal utility box. When assembled and installed on the house, this system will attract lightning strikes away from being direct strikes to the house roof and direct the electrical surge of the lightning strike through the attached cable into the ground for discharge.

- a) Roof-mounted elements must not exceed 1.5-feet in height when measured from the roof surface directly adjacent to the mounting point.
- b) Roof-mounted arrestor rods must be a minimum of 6-feet apart.

- c) Exterior wall-mounted cable or wiring must be routed at right angles and must be securely fastened to the house.

**Diagram 6-3: Typical Lightning Arrestor Rods**

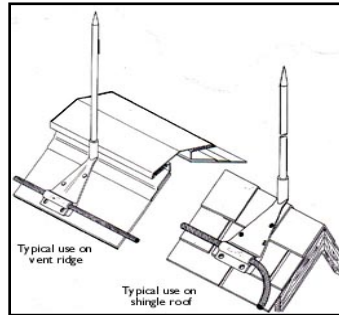

## 6.9 WEATHER STATIONS

### 6.9.1 ROOF-MOUNTED WEATHER STATIONS

The installation of roof-mounted weather stations and related equipment must meet the following requirements:

- Roof-mounted components must not be more than 3-feet above the highest ridge line of the roof.
- Roof-mounted equipment must be painted black to make them as inconspicuous as possible.
- Wall-mounted exposed cable or wiring must be routed at right angles and securely fastened to the house.

### 6.9.2 GROUND-MOUNTED WEATHER STATIONS

- The installation of ground-mounted weather stations and related equipment are permitted providing it meets placement and size restrictions. Ground-mounted weather stations must not exceed 5-feet in height from the developer-finished grade of the lot. Ground-mounted weather stations cannot be installed within 5-feet of any property line. An application must include product information, photos and location of the weather station. Ground-mounted weather stations are prohibited in the final 20-feet of a golf course view lot.
- Fence-mounted weather stations are prohibited.

## 6.10 RAIN SENSORS

Rainfall sensors that incorporate a weather station and connect directly to an irrigation controller are permitted. Such equipment must be no taller than 10-inches in height and 6-inches in width, including the diameter of any wind-measuring device.

## 6.11 RESIDENTIAL TRASH & RECYCLING CONTAINERS

The construction of walls or other visual barriers for the outside storage of trash and recycling containers are prohibited. These containers must be kept inside garages except when they are being made available for collection and then only for the shortest time reasonably necessary for collection. See Paragraph 6 of Exhibit C to the CC&Rs.

## 6.12 CONSTRUCTION/LANDSCAPING DEBRIS BOXES (“DUMPSTERS”)

The placement and use of debris boxes is viewed as an undesirable, but necessary visual nuisance. A debris box may be placed on the driveway for a total time limit that will be set by the MC when reviewing the application for approval, but no longer than 120-days from the approval of the modification. Debris boxes must have reflective materials or cones deployed to enhance safety.

- The placement of a debris box to support emergency demolition and repair resulting from fire or weather is allowed. An application is not required by the MC prior to the placement and use for emergency purposes. See Appendix F, Item #8.
- Planned demolition and construction:
  - An application must be submitted to the MC prior to the placement and use of an approved debris box.

2. A debris box may be placed on the property 2-working days prior to the commencement of the project and must be removed 2-working days after the completion of the project, but no longer than 120-days from the approval of the modification.
3. The debris box may be used only during the course of the approved project.
4. If there is an interruption of the project that exceeds 7-calendar days, the debris box must be removed.
5. The debris box must be placed on the driveway of the home owner's property or, if placed on the street, it requires specific permitting by the CoG.
6. Placement of the debris box on adjacent CA or developer property is prohibited.
7. The home owner is responsible for the use of debris box in conjunction with their projects and must minimize use by other vendors, contractors or third-parties not involved in the project.
8. The home owner is responsible for any debris that spills from or blows out of debris boxes into neighbors' property, CA property or the streets.

### **6.13 COMPOSTING GUIDELINES**

Only in-vessel composting, using vessels specifically designed for composting, is allowed. This is described as a method to confine the composting materials within a container or vessel. Such container or vessel must be located no more than 5-feet from the rear of the rear-most plane of the house, must not be within 20-feet from the right or left side property line and is prohibited in the front of the house. The MC will consider alternate locations if the lot does not meet the 20-foot requirement.

- a) In-vessel composting is limited to two containers per residential lot.
- b) Vessels capacity must not be greater than 60 gallons or 8 cubic feet.
- c) Risers or frames supporting the vessel must be placed on a concrete pad or landscaping pavers.
- d) Only rigid plastic vessels manufactured for composting are allowed.
- e) Vessels must be black, terra cotta or match the primary color of the house.
- f) The home owner is responsible for odor, insect and vermin control.
- g) The screening of vessel must be in accordance with Article 4.13 and Example 4-1.

### **6.14 RESIDENTIAL SECURITY CAMERA INSTALLATION AND USE**

This guideline balances a home owner's ability to install a professional security surveillance system and other security devices for their house with the considerations of privacy and peaceable enjoyment of their neighbors' property. All neighbors have a right to be free from nuisances. The installation of a security system or other security device without approval is prohibited:

- a) Approval from the MC is required before the installation of a security surveillance system and any other security devices.
- b) An application for approval must be accompanied by a plot plan to scale showing the location of any camera or any other security devices. The specifications of any device's material, size, shape, angle and field of view must be included.
- c) Cameras, including those installed inside the house, must not be positioned, installed or operated where a camera views goes beyond the home owner's property. Neighbors have a reasonable expectation of privacy. For example and without limitations, cameras may not be positioned to capture images of a neighbor's doors or windows. The CA has the right to request that one or more CA representatives view the images obtained by the camera to confirm the image area captured by the camera. Failure to comply with the CA's request voids the prior approval of the security system and security devices.
- d) All cameras must be installed in an unobtrusive and non-visible location as reasonably possible.
- e) In addition to all other remedies available, the CA may require any owner in violation of the DG to remove or relocate any security camera or other security device.

### **6.15 SECURITY SIRENS**

The audible component (sirens) of a house security system must be installed inside the residence. No security sirens are permitted to be installed on the exterior of the house.

## ARTICLE 7 – EXTERIOR LIGHTING

### 7.1 EXTERIOR LIGHTING – GENERAL

Exterior house lighting should be minimized and consist primarily of landscape and pathway lighting. Residents can create the desired effect by:

- a) Limiting the number of lighting fixtures and the brightness of individual bulbs.
- b) Use glare shielded landscape and pathway lights that conceal the bulb(s) and direct the light downward.
- c) Use bulbs that produce a color of light similar to natural daylight.
- d) Avoid those producing a cool bluish-white color.
- e) Colored lights are prohibited except for holiday decorations. (See Appendix C.)

### 7.2 DURATION & TIMING OF EXTERIOR LIGHTING

- a) Except for a light dedicated to the night-time illumination of the US Flag and solar powered lights that are not controlled by a timer, exterior lighting on houses, including holiday lighting, should only be illuminated from sunset until 10 pm.
- b) The wall-mounted lights located near the exterior pedestrian doors and garage doors are intended to be used for short periods of time for pedestrian safety, as well as, to facilitate accomplishing short outdoor tasks during periods of darkness. They should be turned off at all other times.
- c) Patio overhead light fixtures mounted on ceiling fans or suspended from or mounted on the interior of a patio roof extension or cover, which may or may not be enclosed by screening, must be fully shielded either directly at the light fixture or by recessing the fixture within the patio roof extension or covered so that the light source is not visible and set to remain illuminated no longer than 10-minutes.
- d) All exterior light fixtures activated by a motion detector must be equipped with a timer. The timer must be set to remain on for the shortest possible time, but no longer than 10-minutes.

### 7.3 MAXIMUM TOTAL BRIGHTNESS

Brightness is a term that describes the measurement of the amount of light falling onto a given surface area. Illuminance relates with how people perceive the brightness of a lighted or illuminated area.

- a) All exterior lighting must be designed/installed so that the total brightness of all unshielded lights in the front/rear of a house do not create a hazard, nuisance or unreasonably interfere with the peaceable use and enjoyment of a neighboring property.
- b) Holiday lighting is exempt from the restrictions on total brightness, as long as, the lights or any lighted decorations are not unduly obtrusive and are not a nuisance.

**Diagram 7-1: Shielded & Unshielded Lights**

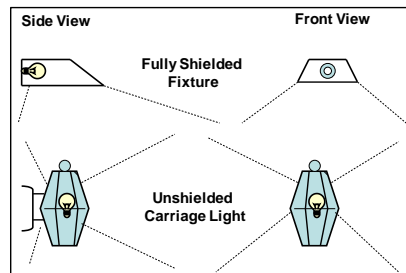

### 7.4 FIXTURE INSTALLATION, LOCATION & SHIELDING

- a) All new or replacement 12 or 120-volt exterior lighting fixtures must be fully shielded. The shield must be made of an opaque material and shaped so that the light source is not visible from neighboring properties.

1. No light may escape above a 90-degree angle measured from the vertical.
  2. Solar-powered lighting fixtures must be fully shielded.
- b) To avoid the glare of the light source, flush-mounted eave-mounted lights may be installed only in horizontal (hip roof) eave soffits and must be shielded 180-degrees to project light only on the adjacent wall. Lights installed in sloped (gable roof) eave soffits are prohibited because they cannot be adequately shielded. These lights are considered decorative and must not be illuminated after 10pm.
  - c) Single or double floodlights may be mounted only at the four corners of the house. They may be switched or motion-sensor activated. They must not be oriented greater than 45-degrees from the vertical and must focus their light on the home owner's lot. Floodlight use must be limited to 10-minutes or less.
  - d) All 120-volt wall-mounted decorative light fixtures must not be larger in size (maximum vertical and horizontal dimensions) than those originally installed.
  - e) Wall-mounted up lights ("wall washers") must be fully shielded and oriented no more than 45-degrees from the vertical. The fixture cannot be mounted more than 3-feet above the finished grade of the lot. Any exterior wiring for up-lights must be buried in a conduit and connected to the fixture from below at a 90-degree angle. Exposed conduit must be painted to match the wall on which the fixture is mounted.
  - f) Ground-mounted up-lights must have their light fully focused within the tree or shrub canopies. Wash-lights must be aimed so that they do not illuminate above the house. The use of ground-mounted up-lights to illuminate above the upper portions of a house or tree/shrub canopies is prohibited.
  - g) Pathway, landscape, patio and deck lighting fixtures must have low-wattage bulbs that direct the light downward.
  - h) Permanent tree-mounted lights are prohibited.
  - i) Polished metal fixtures are prohibited.
  - j) All exterior lighting fixtures must have opaque material. The fixture housing must be brushed brass, copper, stainless steel or a non-reflective material that is painted to match the primary color of the house.
  - k) Installed fixtures must minimize glare. Use bulbs that minimize the amount of light that crosses property lines. Fixtures must be oriented to focus their light on the home owner's lot.
  - l) Lamp posts, whether gas or electric, are prohibited.
  - m) All fixtures must use bulbs that produce a color of light similar to natural daylight. Avoid those producing a cool bluish - white color. The use of colored bulbs including the use of lenses that give the appearance of colored bulbs are prohibited except during designated holiday periods.

## **7.5 FIXTURE MAXIMUM NUMBER, HEIGHT, SPACING & OUTPUT**

- a) A pathway light is defined as a ground-mounted light fixture that is intended to assist pedestrians' access to and from a house.
- b) The maximum allowable combined total of all pathway, landscape, up-lights, eave-mounted, soffit-mounted, deck and patio light fixtures depends upon the total square foot area of the home owner's lot. The MC makes the final determination of the number of allowable lights.
- c) All fixtures must be powered by either a 12 or 120-volt power source or be solar powered.
- d) The maximum height of pathway and landscape lights must not exceed 3-feet above the developer-finished grade.
- e) Pathway lighting fixtures must be at least 4-feet to 6-feet from each other and from any other ground-mounted light fixtures. Pathway lighting fixtures at steps, elevation changes or pathway direction changes may be closer than 4-feet to 6-feet.
- f) Landscape lighting fixtures must be at least 10-feet from each other and from any other ground-mounted light fixture.
- g) Patio and deck lighting fixtures must be at least 6-feet from each other.

## **7.6 MOTION-ACTIVATED LIGHTING**

Light fixtures connected to a motion detector must be equipped with a timer set for no more than 10-minutes.

- a) The fixture's bulbs must be fully shielded with the light focused on the home owner's lot. See Diagram 7-1.

- b) The fixture must not create a hazard, nuisance or unnecessarily illuminate or substantially interfere with the peaceable use and enjoyment of neighboring property.
- c) The motion-detector activator must be adjusted so that it is only activated by movement on the home owner's property.

## **ARTICLE 8 – BARBECUES, FIREPLACES, WOOD STOVES, FIRE PITS & SIMILAR ITEMS**

### **8.1 NON-PERMANENT OUTDOOR FIREPLACES, FIRE PITS & SIMILAR ITEMS**

Non-permanent wood-burning fireplaces, fire pits and similar structures are prohibited. Chimineas and other similar items are prohibited.

### **8.2 PERMANENT FIREPLACE, WOOD STOVE, FIRE PITS & SIMILAR ITEMS**

- a) Permanent gas-burning fireplaces, stoves, fire pits or similar structures require MC approval in addition to a permit from the CoG.
- b) All houses may have one outdoor gas-burning fireplace, stove or fire pit in the rear yard of the house.
- c) Custom Homes have a choice of only one of the following: outdoor gas-burning or wood-burning fireplace, stove or fire pit if installed in the rear of the house.

### **8.3 BARBECUES & GRILLS**

#### **8.3.1 BUILT-IN BARBECUES & GRILLS**

- a) Must be for cooking only.
- b) Must be located within the rear yard and be designed as an integral part of the property. Location must be carefully planned to minimize smoke or odors affecting neighboring properties.
- c) Must be fueled by natural gas, bottled gas or charcoal briquettes.
- d) Wood chips are prohibited unless they are used solely for the purpose of smoking food.

#### **8.3.2 PORTABLE BARBECUES & GRILLS**

- a) Must be located and used only in the rear yard of the house.
- b) May be used anywhere else on the home owner's property during participation in a block party or other neighborhood event. After the event, any portable barbecue or grill must be removed to the rear of the house or an appropriate storage location as soon as they can be safely handled.
- c) Portable barbecues and grills must be stored in a way that they cannot be seen from the street. Barbecues and grills stored on a patio are considered to be properly screened. Barbecues and grills stored elsewhere behind the house must be screened in accordance with Article 8.3.2. (d).
- d) Side-yard and backyard storage of portable barbecues and grills must be screened if the side-yard or backyard has a street view. (See Example 4-1.)
- e) Portable barbecues and grills must be fueled only by natural gas, bottled gas, charcoal, natural wood charcoal, briquettes or wood pellets.
- f) Wood chips may only be used for the purpose of smoking food.

## **ARTICLE 9 – FENCES**

### **9.1 ALL FENCES – GENERAL CHARACTERISTICS & REQUIREMENTS**

Prohibited fences: wood and wood-like concrete composition fences. Developer-installed boundary fences are excluded. All fences must conform to the following characteristics:

- a) Only black wrought iron, aluminum or galvanized steel may be used.
- b) The term "black wrought iron fences" is used, it refers to actual black wrought iron fences or fences made of approved substitute materials, including aluminum or galvanized steel painted black, resulting in the appearance of black wrought iron.



- c) Fence sections must be made with horizontal and vertical elements at right angles to each other forming a grid.
- d) Scrolls, patterns or additional straight elements that are not at right angles are prohibited.
- e) The height of fences must be 4-feet as measured from the developer-finished grade to the unadorned top rail. However, the height of the fence may average as much as 4.5-feet over the length of a segment constructed on sloping ground.
- f) Pickets must be 5/8-inch square and spaced 4-inches or less apart.
- g) All posts must be 2-inches square and secured in concrete.
- h) Top rail of the fence must be a flat, horizontal bar. Fences, initially installed with spikes, may be modified by welding a flat or angled strip on the top of or over the spikes.
- i) Fences along property lines built on a common-property line must serve as shared fence by the home owners on both sides of the fence. Parallel fences are prohibited. Home owners are encouraged to coordinate with neighbors if they connect a new fence to an existing fence.
- j) Other items such as flowerboxes, decorative items, bird feeders, mosquito sprayer system, small animal fencing, rain gauge and similar items are allowed to be attached to a fence. Neighbors should coordinate before such items are installed. The attachment of any other items will be considered by the MC. The application must provide photographs of the items and drawings showing where the items will be installed. Any attachment to the fence must not extend more than 1-foot above the top rail. Attachments that have sharp, pointed or dangerous features are prohibited.
- k) Masonry fence columns are subject to the following specifications:
  - 1. Column dimensions must be between 12-inches and 16-inches on each square side. A square flat capstone of the same dimensions as the column is allowed, however, if no capstone is used, the top of the column must be square, flat and the same width and depth as the column. No part of a column may extend beyond the home owner's property line in any direction. Columns may not be higher than 5-feet.
  - 2. Columns must be made of mortar-set stone or brick or concrete covered with stucco. Column material must complement the finish of the house.
  - 3. Column color must match approved colors used on the house.
  - 4. No columns may be closer together than 25-feet and all columns must be located wholly within the home owner's property.
  - 5. Columns on corner lots must not be located within the Public Utility Easement (PUE).
  - 6. Fence segments bordering on CA common area must not enclose any portion of the common area.
- l) Fence Gates:
  - 1. May be located on any segment of the fence.
  - 2. Must be of the same design as the fence.
  - 3. Must not be located in side segments of the fence providing entry to another home owner's property unless both home owners have agreed to this arrangement in writing with the provision that the gate will be replaced with a solid fence panel when one house is sold. A new home owner may elect to make the same arrangement and provide a written copy of the agreement to the CSD.
- m) Enclosed Area: A perimeter or patio fence must result in a single enclosed area and have at least one gate. Pool and spa fences have additional requirements. (See Article 9.2.)
- n) Small Animal Fencing:
  - 1. Provide for the restraint of smaller pets when the standard picket spacing distance is too great.
  - 2. Must be made of black vinyl coated wire with a mesh of 1-inch x 1-inch or greater.
  - 3. Must not exceed 2-feet in height measured from the developer-finished grade. The MC will consider a request for a higher small animal fencing.
- o) Dog runs of all sizes and configurations are prohibited.

## **9.2 POOL FENCES**

- a) A specific pool fence must be installed as a safety precaution around any pool or spa in accordance with CoG regulations. Fencing must be addressed in any application for a pool or spa.
- b) The general characteristics described in Article 9.1 apply.

**9.3 DECORATIVE FENCING**

The installation of decorative fencing to border or delineate flower beds, trees, tree-wells or any other element on a residential property is prohibited.

**9.4 PERIMETER FENCES**

Perimeter fences may be installed in the rear and side yards, with the following dimensions and characteristics:

- a) A perimeter fence on interior lots must extend from the house at a 90-degree angle to the side-property line then extend to each rear corner of the lot and continue on the property line to connect with the next section of fencing.
  1. May not be closer than 55-feet from the front-property line.
  2. Houses with a side-service door may have the fence on the door side extend closer than 55-feet from the front property line to include the door in the enclosed area, but must be set back at least 15-feet from the front plane of the house.
  3. The fence must be attached at a 90-degree angle to the house or a post next to the house.
- b) A perimeter fence on a corner lot that is adjacent to the side street must extend from the house either toward the rear-property line or off the side of the house towards the side street at a 90-angle:
  1. The front-property line is normally 10-feet from the edge of the street. The area from the edge of the street to the front-property line is typically a PUE. Fences that extend into the PUE area run the risk that the utility easement holder may remove all or part of the fence to access their easement.
  2. The PUE area extends along the side street. A fence must not extend into the PUE area and must be at least 10-feet from the edge of the street.

***Diagram 9-1: Interior Lot Perimeter Fence***

***Diagram 9-2: Typical Corner Lot Perimeter Fence***

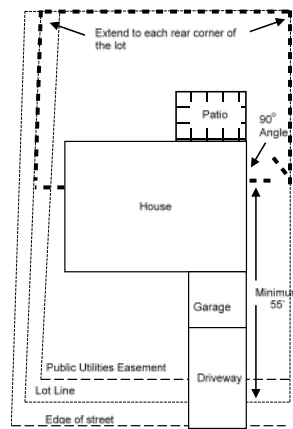
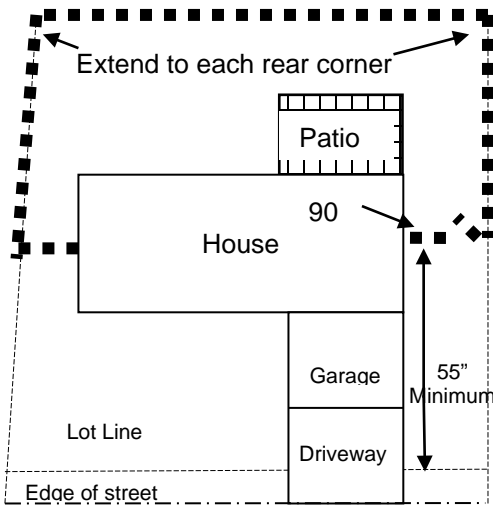

Typical Home, Corner Lot

Typical Perimeter Fence

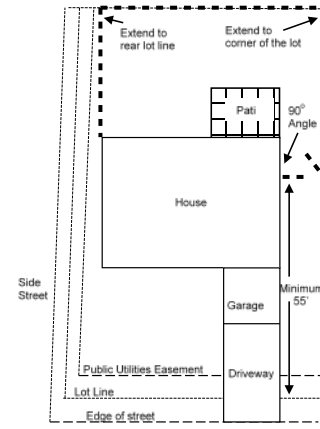

Typical Home, Corner Lot

Alternative Perimeter Fence

## 9.5 PATIO FENCES

### 9.5.1. PATIO FENCES – ALL HOME OWNER MAINTAINED HOMES, EXCEPT NEIGHBORHOOD 38 (NH38) COURTYARD HOMES (SEE ARTICLE 9.9)

Patio Fences may be installed in the rear yard to enclose either a patio or courtyard area. A patio fence consists of either three or four segments:

- First Segment:** This segment defines the depth of the enclosed area. The depth is measured from the house's rear plane to the second segment of the fence paralleling the house's rear plane. It must not be less than one-half of the width of the house and no more than twice the width of the house. It must make a 90-degree angle to the rear of the house and a 90-degree angle when joined to the second segment.
- Second Segment:** This segment of the fence defines the length of the enclosed area. It must be parallel to the rear plane of the house. As a minimum, it must end at a point that is both parallel to the rear plane of the house and the side plane of the house. As a maximum, it must extend to the side property line. It must not exceed 100 percent of the width of the home; however, the distance required to reach the side property line is excluded from the 100 percent maximum. If it extends beyond the side plane of the house, it must extend to the side property line. If it terminates short of the property line, it must end at a point that is parallel to the rear plane of the house and the side plane of the house. It must make a 90-degree angle when joined to the first and third segments.
- Third Segment:** This segment of the fence parallels to the side plane of a house or side property line and extends toward the front of the house. If it extends to the side property line, it must be along the property line and parallel the side plane of the house. If it does not extend to the property line, it must end at a point that is parallel to the rear plane of the house and the side plane of the house. As a maximum, it must extend to a point no closer than 55-feet from the lot's front property line. It must make a 90-degree angle when joined to the second and fourth segments.
- Fourth Segment:** There is no fourth segment if the patio fence area is totally behind the house. The fourth segment is only required if the length of second segment extends to the side property line. It must be perpendicular to the side plane of the house and must make a 90-degree angle to both the house and third segment. As a minimum, it must extend from the rear of the house to the third segment. It must parallel the rear plane of the house. As a maximum, it must extend to the side property line and must not be closer than 55-feet from the lot's front property line.
- Gates:** No more than three gates may be installed. At least one gate must be located in the fourth segment of the fence. A second gate must be installed in any other segment if the fence extends to the side property line. If the fence does not extend to the side property line, the gate must be located behind the home and not be visible from in front of the house.

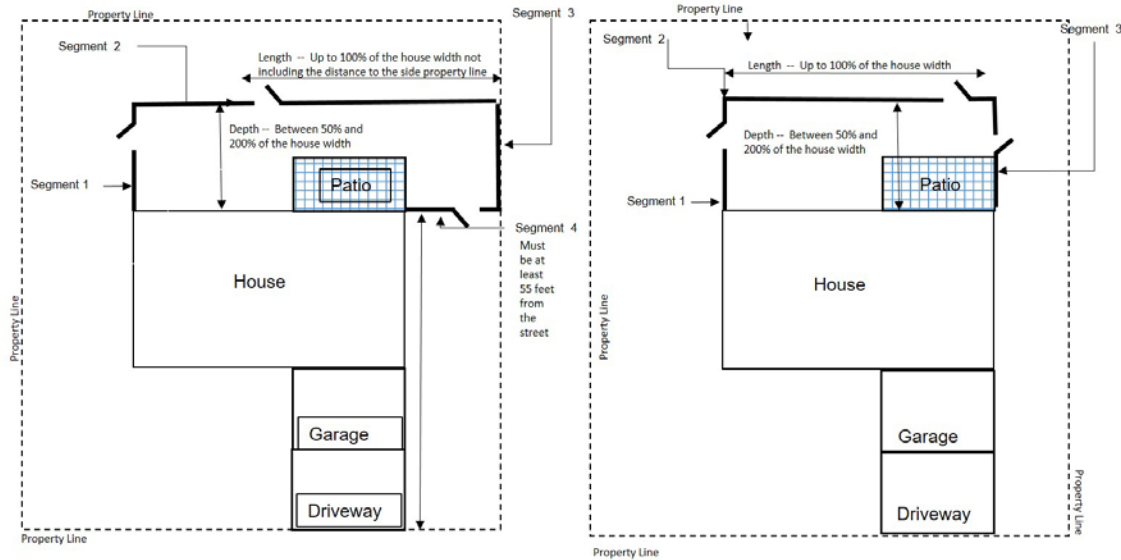
**Diagram 9-3: Illustration Alternative Patio Fence Installations**

## 9.6 DECORATIVE PORCH & PATIO GATES

An on-porch/patio gate may be installed to enclose a porch or patio in the front or rear of a house. The gate material and color must be the same as the fences. (See Article 9.1.)

- Gates must be mounted on the porch and connected to either a wall or post at the wall and must not be more than 1-foot from the edge of the porch.
- Gates must not be taller than 4-feet measured from the porch surface to the top of the gate.
- Gates must be non-lockable, have a self-closing spring to latch and will have an open design with pickets spaced 4-inches or less apart. Decorative gates with the Texas Lone Star or other decorative designs will be considered.
- Small animal fencing may be attached to decorative gates.

## 9.7 NEIGHBORHOOD 38 (N38) – PERIMETER FENCES CHARACTERISTICS

Perimeter fences in N38 are composed of at least five segments and could be as many as nine segments:

- One rear yard segment.
- One (or three) side yard segments on the patio side.
- One (or three) side yard segments on the non-patio side.
- One connection segment on the patio side from that side's segment to the house.
- One connection segment on the non-patio side from that side's segment to the house.
- The general characteristics described in Article 9.1 apply.

## 9.8 NEIGHBORHOOD 38 (N38) – PERIMETER FENCE REQUIREMENTS

- The use-easement provisions for N38 lots and existing drainage easements combine to make fencing guidelines for this neighborhood particularly complex. The objective of the following provision is to ensure that all property owners in N38 may apply for the installation of a perimeter gated fence that complies with the unique use-easement provisions inherent to each property:
  - Must permit access to their lot.
  - Must not interfere with access to the yards of adjacent properties.
  - Must provide for the unique use-easement provisions inherent to each property.
  - Must result in a single-enclosed rear yard with at least one gate.
  - No portion of the fence can cross over a property line or encroach on the neighbors' property unless it is necessary to comply with use-easement provisions.

6. The fence segments that connect to the house must be at a right angle to the house.
  7. All other fence segments must follow the property line and comply with the use-easement provisions.
  8. Fence segments must not encroach upon any drainage easement area and must run parallel to the drainage easement area.
  9. Fence segments bordering a drainage easement area or a CA common area may have gated access to the area. These gates must open inward into the home owner's property.
  10. The home owner's fence must not encroach into a CA common area.
  11. The requirements described in Article 9.1 apply.
- b) Given the complex nature of this neighborhood's use-easement provisions, the MC allows small deviations from these provisions to address conditions unique to the applicant's property.

### **9.9 NEIGHBORHOOD 38 (N38) – REAR PATIO FENCE**

- a) A backyard patio fence must extend to the side property line, but must not extend past the outside corner of the extended patio:
1. Come off the patio/house at a 90-degree angle.
  2. Cannot extend beyond 15-feet from the rear of the patio.
  3. Cannot be located closer than 10-feet from the rear lot line.
  4. The fence section connecting the side fence sections must run parallel to either the rear property line or the rear plane of the house.
  5. Must not enter into any easement area.
  6. If the resulting fence will not produce an enclosed area, the MC will consider additional fence sections around the patio so the fenced-in area is enclosed, but these additions cannot enter into an easement area.
  7. The resulting fence can produce only a single enclosed area on the property. A backyard patio fence and a perimeter fence cannot both exist on the same lot.
- b) In all cases, the general characteristics described in Article 9.1 apply.

## **ARTICLE 10 – SAFETY RAILS, SAFETY GUARDRAILS & WALLS**

### **10.1 HANDRAILS & SAFETY GUARD RAILS**

- a) Porches, patios, decks or raised floor surfaces located more than 30-inches above the floor or the finished grade of the lot must have safety handrails. The handrails must be between 3-feet and 4-feet in height above the walking surface. They must be compatible with the overall approved design of the porch, patio, deck or raise floor surface and securely mounted.
- b) Wooden/synthetic/composite material handrails are permitted for wooden/synthetic/composite material decks. They must be compatible with the approved design of the deck and must be securely mounted to the deck.
- c) Safety guard rails must be installed along walkways where there is more than 30-inches elevation difference between the walkway surface and an area such as a tree well next to the walkway. The safety guard rails must be between 3- and 4-feet in height above the walking surface. They must be securely mounted to provide the required safety.
- d) Wrought iron or black tubular steel handrails are permitted for decks, when compatible with the overall approved design and mounted in a manner that provides the required safety. Wrought iron handrails must comply with all Article 9.1 requirements.

### **10.2 SAFETY RAILS, WALLS AND SEAT BENCHES — HOMEOWNER BUILT**

#### **10.2.1 SAFETY RAILS ON A PORCH OR PATIO**

The following dimensions and characteristics apply to fences and handrails installed around a patio or porch:

- a) Must be mounted on the top of the surface of the patio or porch within 1-foot from the edge of the porch or patio.

- b) Must be between 3- and 4-feet in height above the walking surface of the porch or patio.
- c) In all cases:
  1. The MC may approve custom handrails, safety guard rails and safety rails that conform to the design of the porch, patio, deck, raised floor surfaces or courtyard.
  2. The MC may allow for the customization of form, style and color of the handrails and safety guard rails.
  3. Reflective or highly polished finishes are prohibited.

### **10.2.2. WALLS – HOME OWNER BUILT**

Walls can only be built in the rear yard of a house.

- a) Privacy Walls:
  1. Privacy walls must be made of masonry.
  2. Wood privacy walls are prohibited.
  3. Privacy walls must be a color consistent with the house color and structure.
  4. The maximum height of the privacy wall is 6-feet from the walking surface of the patio.
  5. Privacy walls must be only located on a rear patio. They must be perpendicular to the rear wall of the house, attached to the house and must not extend into setback areas.
- b) Seat Wall (Patio) or Bench (Deck):
  1. Seat walls on front porches are prohibited. Seat walls that are part of a front patio are permitted and must not be higher than 3-feet from the developer-finished grade of the lot.
  2. A seat wall on a rear patio or a bench on a deck must not exceed 3-feet in height measured from the walking surface of the patio or deck.
  3. Seat wall material and color must be compatible with the house's color, material and design.
  4. A bench on a deck must be constructed of the same material and color as the deck. Contrasting materials or colors are prohibited.
  5. A seat wall/bench must not extend beyond the buildable areas of the lot.
  6. Seat walls/benches on a rear deck or patio or a front patio must be at least 3-feet from the property line.

## **ARTICLE 11 – DECKS, PATIOS, PORCHES & COURTYARDS**

Decks, patios, porches, architectural screening, enclosures and shade devices must be designed in harmony with the architecture of the house.

### **11.1 ENCLOSURE OF PATIOS, PORCHES & COURTYARDS – GENERAL**

Home owners with houses that include a covered porch or covered patio may enclose it with screening or a combination of screening and solid material. A porch under the original roof of the house, a fully integrated gabled or hip roof extension can be enclosed with solid material creating additional livable space with HVAC.

The general provisions and restrictions are:

- a) Porches in the front of the house cannot be enclosed.
- b) Courtyards in the front or rear of the house cannot be enclosed.
- c) Exterior finish colors must be compatible with the primary colors of the house:
  1. White panels are prohibited.
  2. Panels must be textured to inhibit reflective glare.
  3. Window or screen framing may be either white to match the original window frames of the house or a color compatible with the exterior walls and trim colors of the house or the screen color.
- d) The rear and side wall of any enclosure must be within the buildable area of the lot.
- e) Any vertical element must not extend into the rear or side set-backs. However, eaves and other approvable architectural features may extend a maximum of 18-inches into the rear or side set-backs.
- f) Roofing any patio enclosure with glass, engineered thermoplastic or any other translucent material, in whole or in part, is prohibited, except:
  1. The installation of a skylight or similar features are permitted in the original roof or roof extension.

2. The use of polycarbonate translucent roof panels or equivalent products may be used in the construction of the roof of a patio enclosure in conjunction with composite roof panels made for that purpose.
- g) Solid-panel roof materials that are warranted to be installed at a pitch of less than 2:12 do not have to meet the minimum pitch requirement of Article 3.3.1 and 3.3.2. The application must include documentation from the manufacturer of the recommended pitch for the product.
- h) Solid-panel roof material is allowed only for the enclosure of patios with screening or a combination of screening and solid panels. Patio covers using solid-panel roof material must not be enclosed using glass, engineered thermoplastic or any other translucent material.

### **11.2 REAR PORCH ENCLOSURE UNDER THE ORIGINAL ROOF OR A FULLY INTEGRATED HIP/GABLED ROOF EXTENSION**

- a) Houses with a porch under the original roof of the house or a fully integrated roof extension, whether built by the developer or added by an independent contractor, may be enclosed with screening, or a combination of screening and solid panels, glass, engineered thermoplastic or any other translucent material.
- b) Complete enclosure of a covered porch with solid components, whether transparent or opaque, will be viewed by the MC as the addition of living space to the original house. In such cases, the planned work will be considered as a room addition and will be viewed in terms of its conformity with Article 3.6.

### **11.3 ENCLOSURE OF COVERED PATIOS**

- a) Home owners with houses that include a covered patio created with solid panel roofing materials may enclose that covered patio with screening material or a combination of screening and solid opaque panels.
- b) Where a combination of screen and solid panels is used, the solid panels must only be the lower portion and/or the upper portion of the wall and are prohibited in the middle portion:
  1. In no case, will the complete enclosure of a covered patio using glass or any weather-proof glass substitute be allowed.
  2. Applicable restrictions to encroachment into the set-back area must be adhered to and are described in Article 11.4.a.
- c) Enclosed patios must not extend into the rear-setback areas.

### **11.4 PATIOS, DECKS OR RAISED FLOOR SURFACES**

- a) A patio is defined as a level surface area without walls and a roof:
  1. Patios must be at least 3-feet from the property line.
  2. Patios must not extend into the side-setback area.
- b) A patio attached to the principal structure:
  1. Must not be elevated above the level of house's main floor.
  2. An attached deck made of wood/synthetic/composite material with a surface more than 1-foot above the finished grade must be skirted to enclose the area underneath the deck:
    - a. Skirting must extend to within 2-inches of grade.
    - b. Skirting must be finished to match the surface and/or railing material or be compatible with the main colors of the house. White skirting is prohibited.
    - c. The entire open area under the patio must be enclosed with skirting.
    - d. Any access to the open area under the patio must be hinged, latched and closed when not in use.
  3. No part of a free-standing patio may be more than 1-foot above the developer-finished grade.
  4. The applications for the addition or extension of patios will include the type and preparation of the sub-strata underlying the finished patio. Home owners applying for an addition to or extension of a patio are required to submit drawings and written details describing the elements and construction of their plan.

**ARTICLE 12 – ARCHITECTURAL SCREENING & SHADE DEVICES****12.1 MAN-MADE AWNINGS, SCREENS & SHADES****12.1.1 AWNINGS – STATIONARY & RETRACTABLE**

- a) Man-made awnings, screens and shades must appear as an integral part of the house and must be made of materials that complement the house and the neighborhood.
- b) Awnings or similar shading devices can only be installed on the rear of the house.
- c) Stationary awnings or similar shade devices must not extend into the rear set-back unless otherwise approved by the CoG and the MC.
- d) Retractable vertical drop awnings or similar shade devices that are guided by vertical wall-mounted tracks are permitted on:
  1. Rear or side-yard windows
  2. Rear porches or rear-covered patios.
- e) Retractable awnings or similar shade devices that extend into the rear or side yard set-backs are permitted.

**12.1.2. SCREENS (INCLUDING SOLAR SCREENS/SHADES) FOR WINDOWS, PORCHES OR PATIO ENCLOSURES**

- a) Window Screens are limited to dark bronze, charcoal, black, taupe, tan or a color that matches the primary color of the house. The frame color must match the color of the existing window framing over which they are mounted or in a color that complements the screen material.
- b) Porch or patio enclosure screens are limited to dark bronze, charcoal, black, taupe, or tan, or a color that matches the primary color of the house. The frame color must match the color of the existing window framing over which they are mounted or in a color that matches the screen material.
- c) Exterior solar shades and any associated hardware are limited to dark bronze, charcoal, black, taupe, or tan, or a color that matches the primary color of the house.

**12.1.3 PROTECTION FROM GOLF BALLS – GOLF COURSE LOTS**

- a) Installation of solutions for protection from golf balls for houses on golf course lots is permitted. Materials must be clear Lexan or other clear and durable material.
- b) Set-backs must be met in all cases.

**12.2 PERGOLAS & LATTICE ARBORS**

Pergolas or lattice arbors must meet the following requirements:

- a) Home owners may install a pergola and lattice arbor as a cover for their patio or deck.
- b) The pergola and lattice arbor must be attached to the house.
- c) The pergola and lattice arbor may have either fixed or adjustable horizontal elements.
- d) The pergola and lattice arbor sides and top may be enclosed with screening and a screen door. Clear Lexan or other clear and durable material may be installed only on the top of the pergola structure.
- e) Pergolas and lattice arbors cannot be enclosed with a combination of glass, glass-substitute, solid or screen panels.
- f) The CoG defines pergolas and lattice arbors as open structures that may extend into the rear set-back area of a lot.
- g) Must be constructed of a material and painted or stained a color that is compatible with the house.

**12.3 TRELLISES & ARBORS – GENERAL REQUIREMENTS****12.3.1 TRELLISES MUST MEET THE FOLLOWING REQUIREMENTS:**

- a) Trellises may be installed to shield ancillary ground-mounted equipment, spa or pool equipment, or to obscure the view of a rear-yard porch, patio, deck or as a free-standing structure.
- b) Must be constructed of a material and be painted or stained a color that is compatible with the house.
- c) Must be between 4-feet and 8-feet in height above the developer-finished grade and no taller than the eave of the house.
- d) Must allow for air circulation and equipment access.



- e) An area enclosed or screened with trellises cannot be used for storage.
- f) Trellises cannot be installed in front of windows or areas that would impede or prevent emergency services access to the house.

### **12.3.2 TRELLISES**

Trellises may be installed to provide shade or as a privacy screen.

- a) This type of trellis may be installed around a covered patio/deck:
  - 1. On the patio/deck: The trellis may be installed at the outer edge of the patio away from the rear wall of the house. The maximum height of the trellis cannot be higher than the bottom edge of the eaves of the house.
  - 2. Off the patio/deck: The trellis must be secured to the patio or deck. The maximum height of the trellis cannot be higher than the bottom edge of the eaves of the house.
- b) Must be painted or stained with a color that is compatible with the paint scheme of the house.
- c) White trellises are prohibited.
- d) Plants or vines growing on the trellises are permitted, but are not recommended per Firewise guidelines.

### **12.3.3 LANDSCAPE/GARDEN ENHANCEMENT TRELLISES & ARBORS**

- a) Trellises may be installed as a landscape enhancement and must be:
  - 1. A single-plane open structure.
  - 2. Made of any durable material.
  - 3. Painted or stained any color that is compatible with the primary house color.
  - 4. White trellises are prohibited.
  - 5. Self-supporting and securely mounted to the ground or a stationary surface.
  - 6. Installed parallel with a wall of the house and must be at least 1-foot from the wall of the house in the front and side yards.
  - 7. Can be installed as a free-standing structure in the rear yard of the house.
  - 8. Cannot be taller than 3-feet from the developer-finished grade in the final 20-feet of a golf course view lot.
  - 9. Trellis bases must be buried in the ground, in concrete or otherwise secured. The attachment of a trellis to a developer-installed fence or wall is prohibited.
  - 10. May be secured to an existing home owner-installed fence. Adjoining home owners must agree to the installation of trellis attached to a common fence line.
  - 11. Trellises placed along a CA-owned Woodcrete boundary fences, developer-installed masonry walls and retaining walls must be at least 1-foot away from the base of the fence or wall.
- b) Arbors may be installed as a landscape enhancement and must be:
  - 1. A three-dimensional structure with the following maximum dimension limits: 7-feet in height, 4-feet in width, and 2-feet in depth. The MC may consider a larger arbor depending upon specific factors.
  - 2. Made of any durable material.
  - 3. Painted or stained any color that is compatible with the primary house color.
  - 4. White arbors are prohibited
  - 5. Self-supporting and securely mounted to the ground or a stationary surface.
  - 6. Can be installed parallel with a wall of the house and must be at least 1-foot from the wall of the house.
  - 7. Can be installed as a free-standing structure in the rear yard of the house.
  - 8. Arbors are prohibited in the front and side yards of a house.
  - 9. Arbors cannot be located within the final 20-feet of a golf course view lot.
  - 10. Arbor bases must be buried in the ground, in concrete or otherwise secured. The attachment of a arbor to a developer-installed fence or wall in any way is prohibited and must be installed at least 1-foot away from the base of the fence or wall.

**ARTICLE 13 – MAINTENANCE STANDARDS****13.1 STRUCTURAL MAINTENANCE**

- a) Damaged, heavily stained (50% or more) or missing shingles on roofs must be replaced by equal or better quality and same color as the shingles being replaced.
- b) Cracked, broken or any damage to glass in windows must be replaced by equal or better quality windows of the same color and style. Window pane dividers/window grilles that have become dislodged or broken must be repaired or replaced.
- c) Exterior house surfaces must be maintained to keep a neat and attractive appearance.
- d) All paint on the house must be free of blistering, peeling or having a degraded appearance.
- e) Stucco and stone work must:
  1. Be free of stains and mold.
  2. Have cracks repaired and painted to match the existing color of house.
- f) Driveways, walkways, patios and other concrete surfaces must be maintained in good repair:
  1. Coated areas must be free of peeling or blisters.
  2. Repaired areas must match the color and texture of the surface being repaired.

**13.2 LANDSCAPING MAINTENANCE**

Landscape maintenance is the responsibility of the home owner and the following are the minimum landscape maintenance requirements:

- a) Established lawns must be mowed, trimmed and edged to keep a neat and attractive appearance. Weeds in lawns must be controlled and must not be permitted to encroach into adjacent lots. Lawns and ground cover must not have bare spots.
- b) Plants and shrubs must be trimmed so the house number placard is viewable from the street.
- c) All trees with limbs that extend over streets, walkways and pathways must have limbs and canopies maintained at a minimum height of 8- feet above the finished grade of the property. Tree limbs over a roofline must be at least 4-feet above the roofline.
- d) All flower beds, tree wells and xeriscape zones must be free of weeds and grasses:
  1. Accepted weed control methods within the community include contracting with lawn maintenance services that are licensed to apply granulated or liquid weed control products, home owner applied granulated weed control herbicides such as commercial "weed and feed" products, spot application of both liquid and granulated herbicides, manual weed removal, or mowing and bagging of weeds prior to seed. The use of natural organic herbicides and pesticides is strongly recommended.
  2. The minimum level of weed control that must be exercised in the community is the mowing and bagging of lawns before any existing weeds bloom and seed.
- e) Shrubs and plants must be pruned to maintain a neat and attractive appearance. The maximum height allowed is the bottom edge of the fascia/trim:
  1. Shrubs and plants must not interfere with the roof-gutter system of the house.
  2. All plants in flower-bed areas must be trimmed so they do not inhibit pedestrian or vehicle passage through driveways, walkways and entry ways.
  3. Shrubs within 2-feet of either side of and below a window must be kept trimmed below the window sill. Shrubs must have a 6-inch to 1-foot clearance from the house.
- f) All shrubs and plants planted within 5-feet of the street must not be taller than 3-feet.
- g) Plants must be planted and remain at least 3-feet from utility boxes and must not impede access to it.
- h) Vines and other plants must not be allowed to grow onto a house's roof. Vines and other plants may be draped across trellises, arbors and other non-structural areas of the house.
- i) Dead, dying, diseased or declining plants and grass must be removed or replaced. Leaves and other debris must be kept away from all flammable surfaces. This requirement does not apply to dormant shrubs, plants and vines.

- j) The use of organic herbicides and pesticides, landscaping products, native and adapted plants and Firewise recommended plants are encouraged.
- k) Home owners must properly dispose of all grass clippings, branches and yard debris. These items must not be disposed of in CA common areas or dumpsters, streets, storm drains, tree wells or neighboring lots.
- l) Planting beds must be maintained with a minimum 2-inch layer of approved hardwood/pine bark mulch or approved inert material.

### 13.3 XERISCAPE LANDSCAPING MAINTENANCE

- a) Care must be taken to avoid creating the appearance of “desert” or “barren” zones. The installation of dead, rotted, or decayed inert material is not allowed.
- b) All xeriscape landscaping materials (river rock, mulch, decomposed granite, etc.) must remain within the approved configuration or boundaries as outlined in the original approved xeriscape landscaping plan.
- c) As required, degraded xeriscape materials must be replenished to maintain the appearance outlined in the original xeriscape landscaping plans.
- d) All areas of inert material must be maintained to retain a weed-free appearance.
- e) Plants installed within an area of inert material must be irrigated. Dead, dying, diseased or declining plants and grass/ground cover must be replaced with the same or similar plants included in the original xeriscape landscaping plan.
- f) Leaves, weeds and debris must be removed at least monthly.
- g) Xeriscape must not be permitted to revert to “Texas Natural” as seen in the CA’s Level 3 and Level 4 areas.
- h) Avoid introducing invasive species into the community. (See [www.austintexas.gov/invasive](http://www.austintexas.gov/invasive).)
- i) Unexpected plant growth must be considered to be “weeds” and removed promptly.
- j) Blowing yard debris into a street, a neighbor’s yard or a common area is prohibited.
- k) Planting beds must be maintained with a minimum 2-inch layer of approved hardwood/pine bark mulch or approved inert material.

### 13.4 METAL SURFACE MAINTENANCE

All metal areas on and around the house such as mailboxes, gas pipes and metal roofs over bay windows must be maintained to retain their original color and finish or natural patina. Gas pipes must be painted for safety.

## ARTICLE 14 – LANDSCAPED MAINTAINED HOMES (LMH)

### 14.1 LANDSCAPE RESPONSIBILITY

- a) The LMH Staff has sole discretion for making all landscaping decisions, including but not limited to:
  1. Trimming or removal of trees or shrubs installed by the developer.
  2. Planting or replacement of shrubs, trees, grass and other vegetation.
  3. Mowing, edging and aeration of turf.
  4. Fertilizing and weed control.
  5. Setting irrigation schedules.
  6. Maintaining and repairing irrigation equipment unless damage to the irrigation system was caused by the home owner then the home owner will be responsible for the repair or replacement costs.
  7. Insect, fungus, disease, etc. control of all vegetation.
- b) Home owners must not interfere with the landscape maintenance services.

### 14.2 LMH HOUSE TYPES

- a) Garden homes (single detached houses) located in N14A, N24A, N25, N30
  - b) Cottages (duplexes) located in N24B1, N24B2 and N33
- NOTE: The DG apply to both the garden homes and cottages in the LMH neighborhoods unless the DG indicate exceptions.

**14.3 GARDEN HOMES – N14A, N24A, N25 & N30**

The standards that apply to cottages apply to the garden homes except:

- a) Neighbor approval is not required for changes made to exterior of house or yard.
- b) Garden homes are limited to four decorative items per lot.
- c) Garden homes are not limited to original house color schemes. (See Article 3.15)
- d) Perimeter fencing must start at the rear side corners of the house and cannot extend beyond 15-feet from the rear wall of the house. Fencing must be at least 10-feet away from the rear property line.
- e) Patio additions or extensions are permitted. However, no extension or addition will be approved if it is determined to have an adverse drainage impact upon neighboring properties.
- f) Path-way lighting and landscape lighting fixtures must be located within the landscape beds in a manner that it does not interfere with or require special care by landscape maintenance personnel. Anything installed in the landscaping beds is installed at the home owner's risk.

**14.4 COTTAGES (MONTEREY & NEWPORT MODELS) – N24B1, N24B2 & N33**

Each adjoining cottage owner must, at all times, maintain a uniform matching exterior. An application is required from both adjoining home owners. Contact the CSD CSO for more details and clarification.

**14.5 COTTAGE REAR-YARD PRIVACY LATTICE DIVIDERS & TRELLISES**

- a) Arbors are not permitted.
- b) Home owners are required to maintain rear-yard wood privacy lattice dividers. If they become damaged, the home owner can either repair, replace or remove it.
- c) An application can be submitted by one home owner, however, the owner of the adjoining cottage must also sign the application to indicate they approve of the modification. All costs to either repair or replace a lattice divider must be borne by both home owners. LMH Staff has a resource to remove these dividers at no cost to the home owner.
- d) Trellises must only be installed in beds covered with river rock. They must not be installed in mulched beds. Trellises are restricted to the planting beds located in the rear-third of the house.

**14.6 ANNUAL BEDDING PLANTS**

Home owners may add annual bedding plants to flower beds and mulched areas at their own expense. The home owner is responsible for the installation, maintenance, removal and disposal of these bedding plants at the end of the growing season.

**14.7 DECORATIVE CONCRETE FENCES – FRONT YARD**

It is the home owner's responsibility to care for and maintain the concrete decorative fencing. This item does not fall under the LMH maintenance responsibility. Home owners may either maintain the fence in good condition, replace or remove the fence. Both adjoining home owners must submit an application before making any changes to the fence. The cost of modifying, repairing or removing is to be shared by both home owners.

**14.8 COATING DRIVEWAYS, WALKWAYS, FRONT PORCHES & REAR PORCHES/PATIOS**

- a) Monterey model:
  1. Coating the shared walkway of the adjoining cottages from the driveway to the front porch must be done in its entirety and at the same time by the same contractor. Coating individual cottage front porches at the same time is not required.
  2. It is not required that both front porches, rear porches and patios be coated at the same time.
  3. Only approved coating colors and textures are permitted.
- b) Newport model:
  1. Adjoining cottages are not required to coat walkways, front or rear porches or patios at the same time.
  2. Only approved coating colors and textures are permitted.

- c) Driveways for both Monterey and Newport models:  
Driveways for both adjoining cottages must be coated at the same time using the same approved coating color and texture at the same time by the same contractor. The only exception is if the developer-coated only one driveway and not the adjoining cottage's driveway. A request for a variance will be considered in this situation.
- d) Contact the CSD CSO for information about approved coating colors and textures.

#### **14.9 DECORATIVE ACCESSORIES & SIMILAR ITEMS ON EXTERIOR WALLS OR IN FLOWER BEDS**

- a) Artwork and ornaments must not be placed in the lawn. These items may be displayed or installed in flower beds or on the exterior walls with the following restrictions:
  - 1. The maximum diameters or art/ornamentation on the front porch exterior wall are as follows:
    - a) Monterey: 2-feet maximum diameter
    - b) Newport: 1-foot maximum diameter
  - 2. The maximum diameter of art/ornamentation on side garage walls on both cottage models is 2-feet.
  - 3. Garage walls on cottage models: Flags and flag mounts must only be installed on street-facing walls.
  - 4. The maximum diameter of art/ornamentation on a rear patio wall is 2-feet.
  - 5. Decorative objects for the cottages are limited to three items per home owner lot. Anything installed in the landscaping beds is installed at the home owner's risk:
    - a) The three objects may include a combination of bird baths, up to two shepherd hooks within 2-feet of the house slab, benches, birdhouses, free-standing statues, fountains, etc.
    - b) The maximum height of these objects is 3-feet in height. Items installed in planting beds in the rear-third and in the rear of the house may be 5-feet in height.
    - c) No decorative object/ornamental items or additional plants may be placed/planted in the yard or in any tree wells.
- b) Flower Pots, Boxes and Other Plant Containers. Anything installed in the planting beds is installed at the home owner's risk:
  - 1. Additional flowers/plants may be added in containers that rest on hard surfaces such as patio, porch or landscaping rock.
  - 2. Containers for such flowers/plants must not exceed 5-gallon capacity. No more than three containers per planting bed or located on a rear patio or porch.
  - 3. A total of six containers are allowed for houses with extended porches/patios.
  - 4. Flower pots must not be installed in the front planting beds that are located in front of the decorative concrete fencing or the small beds located in front and between the Newport's garages. If no concrete decorative fencing exists, flower pots can be placed in the section of planting bed closer to the house.
  - 5. Planter boxes may be installed by the home owner on the decorative concrete front rails or under the garage windows. All planter boxes must be identical in size, style/model and a color compatible with the house color.
  - 6. Anything installed in the planting beds is installed at the home owner's risk.

#### **14.10 FRONT SCREEN, STORM & DESIGNER DOORS**

- a) Screen doors, storm doors and upgraded-designer front doors may be installed provided the style is compatible with the house design and meets the DG requirements. An application is required. The adjoining home owner does not need to sign the application or install a matching door.
- b) Door color must be compatible with house colors and existing door frame.

#### **14.11 REAR-YARD FENCES**

- a) A perimeter fence for cottages is not allowed.
- b) Cottages may install a rear-yard fence that extends from the rear corner of the house with a maximum depth of 8-feet and must extend in width to the privacy screen between the cottages. If no privacy screen exists,

the fence must extend to the exact center of the cottages and must be securely attached to the exterior house wall or a post adjacent to the rear wall. (See Article 9.1)

- c) The home owner installing the fence is responsible for all landscaping in the fenced area. The LMH landscaping contractor retains responsibility for the irrigation system. (See Article 14.1.) The LMH landscaping maintenance contractor will no longer provide landscaping services within the fenced area.
- d) The LMH contractor will continue to maintain the yard outside the fenced-in area and must have full access to the fenced-in area.
- e) The home owner is responsible for maintaining any plants located inside or under the fence and must follow all requirements set forth in the DG.
- f) There will be no reduction in maintenance fees for cottages with a rear fenced-in yard.
- g) Within the fenced area, the home owner may install an optional patio including a pergola-type patio cover. Both ends of the fence must be connected to the house or connected to a post next to the privacy screen.
- h) The fence cannot be attached to the privacy lattice screen if one exists.
- i) If a fence is removed, the home owner must reinstate all landscaping to the LMH landscaping standard or as determined by the LMH Superintendent. The LMH contractor will resume maintenance of the yard after all landscaping is reinstated.

**Diagram 14-1 Typical LMH Garden Fence**

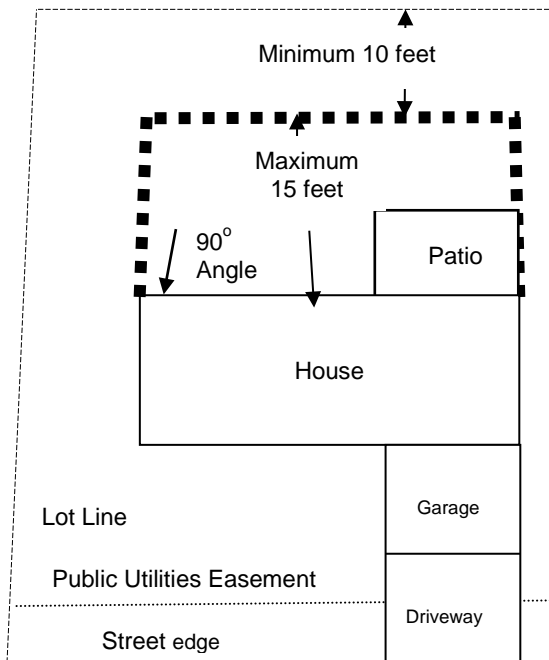

**Typical Landscape Maintained Garden Home  
Maximum Size Backward Fence**

**Diagram 14-2 Typical LMH Cottage Fence**

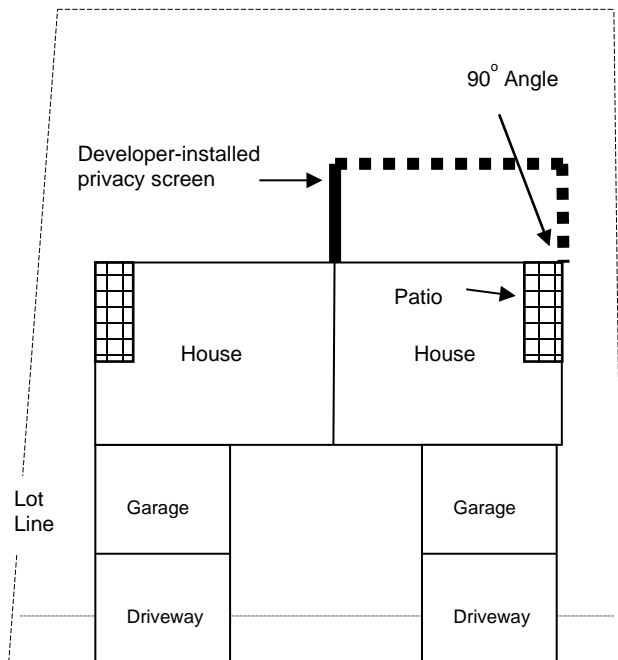

**Typical Cottage Home  
Maximum Size Backyard Fence**

**14.12 FENCES – ON-PATIO, ON-PORCH & HANDRAILS**

Fences must be installed on the top surface of rear patios. (See Article 10.1. and 10.2.1.)

**14.13 IRRIGATIONS/SPRINKLER SYSTEM CONTROLS & SOIL MOISTURE SENSORS**

Irrigation system components and control equipment must not be accessed or altered by anyone other than the CA LMH Staff or the LMH landscaping maintenance contractor. Work on the house landscaping may require irrigation system access or alteration and will only be done with the LMH Superintendent’s prior permission.

**14.14 LIGHTING & LIGHTS**

- a) Exterior, Path and Landscape. Anything installed in the landscaping beds is at the home owner's risk:
  1. Path lighting and landscape lighting fixtures must be located within the planting beds behind the decorative concrete fencing and must be installed so that they do not interfere with landscape maintenance or require special care by landscape maintenance personnel.
  2. If no decorative concrete fencing exists, the landscape lighting fixtures must be placed in the planting beds closest to the front of the house.
  3. All applications for exterior lighting changes require both the original signatures of the home owner and adjoining home owner indicating approval by both parties.
- b) Garage carriage lights:
  1. Both adjoining cottages must have the exact same style of carriage lights.
  2. An application must be submitted showing a picture of the current and replacement carriage lights giving details such as style, height, depth, width, color and size of recommended light bulb.
- c) Overhead Front Porch Light:
  1. If the front porch overhead light becomes defective and cannot be repaired, the home owner must replace the light fixture with a fixture that is exactly the same style, size and color of the original.
  2. If the original style of light fixture is not available, the home owner may install a light fixture of similar design, size and color. Adjoining home owner is not required to follow suit.
- d) Lighted House Address Numbers:
  1. House address numbers are to remain lighted 24-hours a day.
  2. Address numbers within the plate must all be of the same style and color.
  3. Both adjoining cottages must have the same style of plate and address numbers. Contact the CSD CSO for address plate and number information.

**14.15 MAILBOXES****14.15.1 ADJOINING COTTAGES**

- a) Both mailboxes must be kept in good condition.
- b) When the one mailbox painted finish deteriorates to the point that it needs to be repainted both mailboxes must be painted the original color and finish at the same time by the same contractor.
- c) When the address numbers for either cottage need replacement, both cottage address numbers must be replaced at the same time with the original number style and color. Contact the CSD CSO for replacement/repair of address plates and/or address numbers information.
- d) If a mailbox is beyond repair, it must be replaced with the exact same style, color and finish as the developer-installed mailbox. Contact the CSD CSO and CSD web site for mailbox information.

**14.15.2 SECURE-LOCKING MAILBOXES**

Secure locking mailboxes designed with one or two retrieval doors for both front and rear access are permitted providing:

- a) An application is submitted.
- b) It meets US Postal Service approval.
- c) It is post mounted in the location of the original developer-installed mailbox.
- d) It is similar in design to the developer-installed mailbox.
- e) Does not exceed 11.3-inches wide by 11.5-inches high by 20-inches deep.
- f) It is made of black galvanized steel.
- g) The address numbers are white and the same original style font.
- h) The adjoining home owner is not required to install a matching mailbox.

**14.16 PAINTING LMH HOUSES**

- a) Must use the original paint color scheme. No exceptions will be made.

- b) Both cottages must have all sides painted at the same time by the same contractor. No exceptions will be made.
- c) Paint color scheme information can be obtained from the CSD CSO and CSD web site.

#### **14.17 PATIO ADDITIONS**

- a) Only rear patio additions are allowed and must be approved by CA LMH Staff to ensure the integrity of the irrigation system. Patio additions must not exceed the following dimensions:
  - 1. Monterey: 6-feet deep x 15-feet wide
  - 2. Newport: 8-feet deep x 20-feet wide
  - 3. Patio can be made of poured concrete, treated wood, wood composite or other DG-approved materials.
- b) Any planting beds removed or destroyed, as a result of an addition of a rear patio, must be replaced per landscaping design guidelines at the home owner's expense.
- c) Home owner must submit a landscaping plan showing size of area, number and names of plants along with a description of irrigation changes.
- d) Irrigation changes must only be made by a licensed irrigator or the LMH landscaping maintenance contractor.

#### **14.18 POOLS, SPAS, PONDS & HOT TUBS**

Pools, spas, hot tub or ponds will only be permitted on patios or approved patio extensions.

#### **14.19 ROOFING REPAIR OR REPLACEMENT**

- a) Both units of the LMH home must be re-roofed in its entirety at the same time by the same contractor using equal or better-quality asphalt shingles. No exceptions.
- b) An approved shingle color must be used.
- c) If the roof requires minor repairs only, the exact style and quality shingles of must be used to make the repair.
- d) Possible exception: Upon approval by the MC, if only one side of the adjoining roof requires replacement while the other adjoining roof does not, the damaged roof may be replaced providing the roofing material is exactly the same style, quality, color as the existing roof and is feathered seamlessly into the adjoining roof so no delineation between the two roofs is apparent.

#### **14.20 SOLAR-PANEL INSTALLATIONS**

Solar panels may be installed on one side of adjoining cottage without the requirement for the other cottage owner to install solar panels. Refer to Article 6.6.

#### **14.21 WILDLIFE PROTECTION FENCING**

Wild life protection fencing is prohibited for LMH houses.

#### **14.22 WINDOWS & WINDOW PANE DIVIDERS/GRILLES**

Cracked, broken, or damaged glass in windows must be replace by equal or better quality windows of the same type and color. Window pane dividers/grilles that have become dislodged or broken must be repaired/replaced.



**APPENDIX A – DEFINITIONS & TERMINOLOGY****2:12: (See Pitch of Roof)**

**AAG:** Architectural Advisory Group Sub-Committee, an authorized sub-committee of the MC.

**Aesthetics:** A pleasing appearance or effect. In the context of the MC, dealing with the nature of appearance and informed judgments concerning appearance.

**Approved Debris Box or Dumpsters:** A debris storage container also known as a dumpster.

**Arbor:** A double-plane structure or a shelter having height, width, and depth. It may or may not bear vines or plant material.

**Architectural Screening:** A perforated panel, the purpose of which is to obscure an item from view.

**Attached House:** A single family residence that shares a common wall with another residence; the “Cottages”.

**Back Yard:** See Yard, Back

**Benefited Lot:** An N38 lot that has a use easement on an adjacent lot.

**Build Line:** The line defining the maximum extent of the buildable space on a lot; also, the “Set-back” line.

**Building Envelope:** The separation between the interior and the exterior of a building. It serves as the outer shell to protect the indoor environment as well as to facilitate its climate control.

**Burdened Lot:** A residential lot in N38 that grants an easement on an adjacent lot.

**CA Property:** Property belonging to the CA.

**CMU Block:** “Concrete Masonry Unit” A pre-cast solid or hollow concrete block.

**Color Scheme:** A fixed relationship of paint colors that defines the approved colors to be used on the stucco, garage, fascia, columns, pop-outs, front door, shutters and gable vents of a house.

**Common Area:** See CA Property.

**Cottage (The Cottages):** A single family residence sharing a common wall.

**Courtyard:** An area that is partially or fully enclosed by a house and/or by walls and that is not covered by a roof.

**Courtyard Houses:** A single family detached residence sited on a lot with narrow side set-backs.

**CTP Zone (Color/Texture/Planting Zone):** An area of plantings, turf, living ground cover and/or inert bedding material that share a common irrigation requirement.

**Custom Homes/Houses:** Houses not built by the developer in N16 and N20.

**Date of Approval:** The date that MC approves an applications.

**Deck:** A level surface structure connected to the house with no outer walls or roof; made of wood or approved substitute material.

**Declarant:** Sun City Texas community’s developer

**Declaration (CC&Rs):** The Declaration of Covenants, Conditions, and Restrictions.

**Decorative Fencing:** Fence-like structure that is purely decorative and does not serve as a barrier. It may be made of metal, metal wire, plastic, wood or other material.

**Detached Houses:** A single family residence sharing no common wall with another residence.

**Design Guidelines:** This document which provides standards and procedures for the modification of houses and lots within the Sun City Texas community.

**Developer:** Del Webb Texas Limited Partnership controlled by Pulte Homes.

**Developer-finished Grade:** See “Finished Grade.”

**Dimensions:** The measure in one direction, for example; length, width, depth or elevation.

**Dog Run:** A rectangular fence enclosure with one dimension of 10-feet or less and the dimension of the longer side of the rectangle is twice or more in length.

**Drip Irrigation:** A system for plant irrigation involving the controlled delivery of water directly to individual plant root zones through a network of tubes or piping.

**Dumpster:** A receptacle used for the deposit of waste or debris. A debris box.

**Duplex:** A single family residence sharing a common wall with another residence; for example, the Cottages; also, “Attached House.”

**Earth Tone:** A color containing an element of deep rich brown or green.

**Enclosure:** A constructed area of the house, other than fenced; that may be open, as in a courtyard; or, that may be closed, as in a sun room enclosure.

**Eave-mounted Down Lights:** Recessed lighting fixtures with integral shielding, as required. Although allowed in horizontal soffits under hip-roof eaves, such installation in sloped soffits of gable-roof eaves is prohibited.

**Fascia:** The vertical "fascia board" which caps the end of rafters outside a building that is used to hold the rain gutter.

**Fence:** A barrier intended to prevent escape or intrusion or to mark a boundary usually made of posts, metal pickets, gates, masonry or Woodcrete. A fence is not a visual barrier; a wall is a visual barrier.

**Finished Grade:** The final elevation and contour of the ground.

**Flag:** A rectangular fabric that represents a country, city, state, institution or organization; an emblem or icon representing an event or season.

**Garden House:** A single-family residence that does not share a common wall with another residence and is located in an LMH neighborhood.

**Golf Course Lot:** A house that wholly or partially borders on a golf course boundary or has a view of a golf course and has a 3-foot tall restriction in the final 20-feet of the lot.

**Grade:** The slope of the ground measured at ground level at any point on a lot.

**Gravel:** Any loose rock that is larger than 1/2-inch in its smallest dimension and less than 2.5-inches in its largest dimension.

**Greenbelt Lot:** A lot that wholly or partially border on and has a view of a landscaped or natural area.

**Front Yard:** See Yard, Front

**Hardscape:** Any masonry, woodwork, inert, or other non-plant elements installed on a residential lot such as the foot-print of the house, the driveway, any courtyards, paths, patios, pools, ponds, walkways or other features.

**Hedge:** A fence or boundary formed by a dense row of shrubs or low trees.

**Hip roof:** A roof slopes upward from all sides of a structure, having no vertical ends with either the four roof planes coming together at a single point or three plans coming together at each end or a horizontal ridge.

**House, Front of:** The area between the right, front corner and left, front corner of the house including any walls, patios, porches or courtyards. The front plane of the house.

**House, Rear of:** The area between the right, rear corner and left, rear corner of house, and including walls, patios, porches or courtyards. The rear plane of the house.

**House, Side of:** The area of the house that is neither the front of the house or the rear of the house. The side planes of the house.

**House Slab:** The house's foundation that is covered by the original roof of the house.

**HVAC:** Heating, ventilation, and air conditioning.

**Illuminance:** The perceived brightness of a light source.

**Impervious Cover:** Hardscape composed of concrete or stone or a combination of concrete and stone, compacted clays, sands and gravels. Examples include, but are not limited to, walkways, patios, driveways, retaining walls, pools, pathways and ponds.

**Inert Material:** Materials such as rock, hardwood mulch or bark that are deficient in active properties. They may be permeable or impervious.

**Inert Zone:** Part of a xeriscape planting area containing inert material.

**Interior Lot:** Lots that do not border on a golf course, greenbelt, habitat, or nature preserve areas.

**Irrigation Plan:** A scaled drawing of a landscape irrigation system which shows all the necessary information to install or intended changes to an irrigation system.

**Irrigator:** A professionally licensed person with a state-issued registration number that sells, designs, installs, maintains, alters, repairs, services or supervises the installation of an irrigation system.

**Knee Wall:** A substitute term for "seat wall".

**Knox Box®:** A lockable steel box next to a house's front door storing keys to allow emergency personnel to unlock the door.

**Landscape:** The area of a lot other than hardscape that is modified or ornamented with plant cover, e.g. grass, shrubs, flowers, etc.

**Landscape Lighting:** Ground mounted low-voltage lights, either 12-volt or solar powered, that directs the light downward and are placed in a landscape area for decorative purposes.

**Lightning Arrestor (Lightning Conductor or Lightning Rod):** A rod made of materials that are good conductors of electricity that are mounted on top of a house and attached to the ground by a cable that when struck by lightning carries the electrical charge safely into the ground and prevents damage to a house.

**Low-voltage Lighting:** Lights operating with 12-volt power used in landscape areas or along walkways.

**Maintained Houses:** Cottages and garden homes whose landscaping is maintained by the Sun City Texas Community Association.

**Maximum Size of Plantings:** Maximum size of planting means the anticipated height and horizontal dimension of the plant material at full maturity.

**MC:** See "Modifications Committee".

**Modifications Committee:** The Sun City Texas Community Association committee charged with the writing and maintaining the Design Guidelines and reviewing resident applications for house and landscaping modifications.

**Monochromatic:** A single color without an over-lay pattern or visual texture.

**Natural Materials:** Architectural or landscape materials such as rocks, sands, gravels, drift logs and other items used as part of landscaping.

**Neighboring Property:** Any adjoining property including, but not limited to residential property, CA common area, golf course property or any other CA-owned property.

**Nuisance:** See Paragraph 5 of Exhibit C to the CC&Rs (Declaration).

**Original House Closing:** The date of the purchase of the house from the developer.

**Originally Constructed:** A house feature at the time of the original house closing.

**Path/Pathway:** An area intended for the use of pedestrians.

**Pathway Lighting:** Ground mounted low-voltage lights, either 12-volt or solar powered placed along a pathway to assist pedestrians using a pathway.

**Patio:** A surface created as an extension of the footprint of the house that may be located in either the front or rear yard and may be covered or uncovered or enclosed.

**Patio Enclosure:** An enclosure typically composed of a shed roof and curtain wall (non-load bearing exterior wall) with framing glass and/or screen material.

**Patio & Deck Lighting:** Low-voltage lights, either 12-volt or solar powered placed within a patio or deck structural member.

**Patio Fence:** An approved fence enclosing a rear patio or a portion of the rear yard that is within the rear boundary of the property.

**Patio Slab:** The hardscape surface of a patio or patio extension. It may or may not be connected to the house foundation and not under the original roof of the house.

**Pergola:** A structure usually consisting of parallel columns supporting an open roof of girders and cross beams. These may employ a roofing material sandwiched between two sheets of metal or plastic material.

**Pitch of Roof:** The incline of a roof or the ratio of the total vertical rise to the total horizontal run of the roof, i.e., a 2-foot rise for a 12-foot run is a 2:12 pitch roof (expressed in the inches of rise, per foot of horizontal run).

**Pervious Cover:** Any washed rock with no pieces smaller than .75-inch, plastic sheeting with drain holes that permits drainage under any rock and hardwood/pine bark mulch.

**Planted Zone:** A planted zone in a xeriscape landscaping project.

**Pop-Outs:** Typically stucco projections surrounding openings (doors & windows) in exterior walls.

**Porch:** The area under the existing roof of the house is a porch. Usually a roofed open area attached to the front entrance to a house; a roofed platform adjoining an entrance to the house.

**Primary Background Color:** The primary or stucco color of a home. For masonry homes (limestone or brick) a color that complements the color of the masonry.

**Privacy Fence:** A fence that completely encloses an area as a visual barrier is prohibited.

**Privacy Lattice:** A lattice usually on rear porch that provides a visual barrier to adjoining houses.

**Privacy Wall:** A masonry structure attached to the rear of a house that provides a visual barrier when viewed from outside the wall.

**Public Utility Easement (PUE):** – the area along a lot boundary that is freely accessible by the City of Georgetown or their contractors and within which there may be extraordinary restrictions to building or planting.

**Rear Yard:** See Yard, Rear.

**Reviewing Body:** The Modifications Committee.

**Rolled Roofing:** Asphalt roofing products manufactured in a rolled form. Often used as a substitute for 3-tab shingles. The use of this roofing material is prohibited.

**Seat Wall:** A raised structure built along the edge of a patio or deck in the front or rear yard to provide seating and safety. Generally, seat walls are built of the same material as the patio or deck of which it is a part and are integral to the patio or deck and are not more than 3-feet from the walking surface.

**Security Door:** An exterior door unit manufactured for the purpose of providing a deterrent to forceful house entry and is installed outside a house's exterior door(s). A "security door" may have the attributes as a "storm door"; however, a "storm door" only provides protection against extreme weather hazards.

**Set-back:** The open space on a lot that is open that structures cannot be built upon.

**Shade Device:** An overhead lattice covered structure (See Pergola).

**Shed Roof:** Roof design of a single roof plane.

**Side Yard:** See Yard, Side

**Sight Triangle:** The "sight triangle" consists of an area beginning at the intersection of the curbs of corner lots and going 25-feet down each curb line having height restrictions.

**Siren:** The audible component of a home security system.

**Slab:** The "slab" portion of the house foundation under the original roof. It does not include patios, porches or other flat work outside the original roof line.

**Soffit Vent:** A ventilation intake installed under the eaves, or at the roof edge.

**Solar Screens:** Framed screening material mounted on the exterior of window openings to reduce the adverse effect of exposure to the sun.

**Spark Arrestor:** Devices fitted to a flue or chimney pot intended to prevent the escape of airborne fire embers.

**Sun Room Enclosure:** A porch, under the original roof of a house that is fully enclosed with glass or weather resistant glass substitute.

**Supplemental Declaration:** A Declaration of Covenants, Conditions and Restrictions that applies to only a subset of the community.

**Trellis:** A single-plane structure with height and width that creates a latticework used as a visual screen or to support for climbing plants.

**Turf Zones:** An area covered completely by turf grass and/or living ground cover. It may or may not be part of a xeriscape landscaping project.

**Wall-mounted Uplights:** Wall-washing lights installed to create a decorative effect by illuminating parts of a house or landscaping.

**Water Conservation:** The design, installation, service and operation of an irrigation system in a manner that prevents the waste of water, promotes the most efficient use of water and applies the least amount of water that is required to maintain healthy individual plant material or turf, reduce dust and control erosion.

**Water Feature:** An architectural or landscape enhancement that uses running water as a principal component. Water Features include, but are not limited to fountains, waterfalls and artificial streams.

**Weather Stations:** Residential weather stations are, generally, a combination of sensors (wind speed and direction, precipitation, temperature, etc.) mounted on the exterior of the house (the roof) and a receiver installed in the interior. These are connected with a cable/wire or by wireless communication.

**Wood Pellets:** Wood pellets are a biomass material, which means that they are products of commonly grown plants and trees. Residential pellets are often made from the sawdust left behind by the lumber and furniture industries

**Xeriscape:** A landscape design which when built will require 50% or less of the normal amount of irrigation as a turf-based design. This will be achieved by reducing the size of the turf areas on the property, substituting a combination of low water use planting areas, Drip Irrigation and inert material (mulch, rock or stone) beds.

**Yard:** That area of the house owner's property that is not covered by hardscape.

**Yard, Back or Rear:** That area of the House owner's property that is rearward (away from the street) of the rear plane of the house (when facing away from the street), including contiguous portions of the right and left side. Where a house is located on a corner lot the "rear" is always facing away from the street on which the house is addressed.

**Yard, Front:** That area of the house owner's property that is forward (toward the street) of the front plane of the house (when facing toward the street), including contiguous portions of the right and left side. Where a house is located on a corner lot the "front" is always facing toward the street on which the house is addressed.

**Yard, Side:** That area that is not the front yard, nor the rear yard.

**Zero Lot-line Houses:** See NH38 courtyard homes.

**APPENDIX B – COMMONLY USED ACRONYMS**

The acronyms are used throughout this document to save space:

AAG — Architectural Advisory Group

BoD — Board of Directors

CA —Sun City Texas Community Association

CC —Covenants Committee

CC&Rs —Declaration of Covenants, Conditions and Restrictions

CoG — City of Georgetown

CTP — Color/Texture/Planting Area

CSD — Community Standards Department or Community Standards Director

CSD CSO — Community Standards Department Customer Service Office

DG — Design Guidelines

FCC — Federal Communications Commission

GD — Governing Documents

HVAC — Heating, Ventilation and Air Conditioning

IG — Interim Guideline

LED — Light-Emitting Diode

LMH — Landscaped Maintained Homes

MC — Modifications Committee

MIMC — Maximum Impervious Materials Coverage

NPL—No-Paperwork List

NXX — Neighborhood XX

PISL — Prohibited Item and Structure List

PUE — Public Utility Easement

PVC — Polyvinyl Chloride

UDC — Unified Development Code

US Code — United States Code

US Flag — United States flag

UHF — Ultra High Frequency

VHF — Very High Frequency

WCG — Water Conservation Group

**APPENDIX C – RECOGNIZED HOLIDAYS**

The following holidays are recognized wherever holidays are a consideration. If there is a conflict between this list and the Board of Directors-approved list of holidays, use the Board of Directors-approved list of holidays. Some holidays are not bound to a specific date or dates. In such cases, use the generally accepted date or dates for year.

- a) New Year's Day – January 1<sup>st</sup>
- b) Valentine's Day – February 14<sup>th</sup>
- c) Texas Independence Day – March 2<sup>nd</sup>
- d) St. Patrick's Day – March 17<sup>th</sup>
- e) Easter – Friday through Sunday
- f) Halloween – October 31<sup>st</sup>
- g) Memorial Day – Last Monday in May
- h) Independence Day – July 4<sup>th</sup>
- i) Labor Day – 1<sup>st</sup> Monday in September
- j) Veteran's Day – November 11
- k) Thanksgiving Day – 4<sup>th</sup> Thursday of November
- l) Christmas Eve – December 24<sup>th</sup>
- m) Christmas Day – December 25<sup>th</sup>
- n) Hanukkah — Dates Vary
- o) Kwanza — December 26<sup>th</sup> through January 1<sup>st</sup>
- p) New Year's Eve – December 31<sup>st</sup>

## APPENDIX D – NATIVE TREES & RESOURCES ON NATIVE & ADAPTED PLANTS

Native trees are native to Sun City Texas Area and the Edwards Plateau. Other trees may be suitable for planting in the community. The following trees are native to the area and are drought-tolerant and resistant to wildlife damage:

- Elm, Cedar (*Ulmus crassifolia*)
- Honey Mesquite (*Prosopis glandulosa*)
- Mexican Plum (*Prunus mexicana*)
- Oak, Burr (*Quercus macrocarpa*)
- Oak, Southern Live (*Quercus virginiana*)
- Oak, Texas Red (*Quercus texana*)
- Oak, Post (*Quercus stellata*)
- Osage Orange (*Maclura pomifera*)
- Sugar Hackberry (*Celtis laevigata*)

These trees, while not native to the area are drought tolerant and highly resistant to other wildlife:

- Ash, Texas (*Fraxinus texensis*)
- Huisache (*Acacia farnesiana*)
- Mexican Buckeye (*Ungnadia speciosa*)
- Mexican Redbud (*Cercis canadensis var. mexicana*)
- Oak, Shumard (*Quercus shumardii*)
- Texas Redbud (*Cercis canadensis var. texensis*)

Resources on native & adapted, drought-tolerant and firewise plants:

The use of plants native to the area native or adapted to the area that are drought tolerant and firewise are strongly recommended for all landscaping. There are numerous gardening books, periodicals and websites that provide quality information about suitable native and adapted drought tolerant and Firewise plants.

<b>Libraries</b>	CA Library, the Sun City Garden Club/Nature Club Resource Center and Georgetown Library have very good reference material.
<b>Native Plant Society of Texas</b>	NPSOT's promotes the conservation, research and use of native plants and plant habitats through education, outreach and example.
<b>Ladybird Johnson Wildflower Center, UT at Austin</b>	The Center's gardens display the Texas native plants and their database of more than 7,200 native species available online.
<b>Sun City Nature Club</b>	Native Plant Special Interest Group provides education about and encourages the use of native plants.
<b>Sun City Horticulture Club</b>	A group dedicated to organic gardening and sells native plants.
<b>Sun City Garden Club</b>	Speakers and other activities related to Texas gardening.
<b>Texas Invasive Plant and Pest Council</b>	Maintains an online database of plants known cause problems.



## APPENDIX E - RECOMMENDED PLANTS

COMMON NAME	SPECIFIC NAME	NATIVE?	REQUIRED DISTANCE/PLANTINGS NEAR RETAINING WALLS	FLAMABIL ITY HAZARD	WATER	WILDLIFE VALUE	DEER RESISTANT
<b>Avoid if Possible</b>							
Cypress, Arizona	<i>Cyprinus arizonica</i>	yes	10'	high	very low		
Cypress, Bald	<i>Taxodium distichum</i>	yes	10'	high	low		
Cypress, Montezuma	<i>Taxodium mucronatum</i>	yes	10'	high	low		
Juniper (Cedar), all columnar evergreens	various species	yes	10'	very high	low		
Oleander	<i>Nerium oleander</i>	no	10'	med	very low		
Pampas Grass	<i>Cortaderia selloana</i>	no	5'	very high			
Pine	<i>Pinus species</i>	yes	10'	very high	high		
Salt Cedar, Tamarisk	<i>Tamarix ramosissima</i>	inv	10'	medium	medium		
Vitex	<i>Vitex angus-castus</i>	inv	5'	low	medium		

<b>Hardwood Trees</b>							
Cherry, Plateau Black	<i>Prunus serotina var. eximia</i>	yes	10'	low		yes	
Ash, Texas	<i>Fraxinus texensis</i>	yes	10'	low	very low	yes	
Maple, Big-toothed or Red	<i>Acer grandidentatum or A. rubrum</i>	yes	10'	low	very low	yes	
Oak Live Oak	<i>Quercus fusiformis</i>	yes	10'	low	low-very low	yes	
Oak, Post	<i>Quercus stellata</i>	yes	10'	low	low-very low	yes	
Oak, Texas Red	<i>Quercus texana</i>	yes	10'	low	low-very low	yes	
Oak, Shumard	<i>Quercus shumardii</i>	yes	10'	low	low-very low	yes	
Pecan	<i>Carya illinoensis</i>	yes	10'	low	low	yes	
Sycamore Mexican	<i>Platanus mexicana</i>	no	10'	low	medium	yes	high
Walnut, Black	<i>Juglans nigra</i>	yes	10'	low	medium	yes	
Walnut, Texas	<i>Juglans microcarpa</i>	yes	10'	low	medium	yes	

<b>Small Trees</b>							
Buckeye, Mexican	<i>Ungnadia speciosa</i>	yes	6'	low	medium	yes	high
Crape Myrtle	<i>Lagerstroemia indica</i>	no	10'	low	low-medium		
Dogwood Roughleaf	<i>Cornus drummondii</i>	yes	10'	medium	low	yes	
Mountain Laurel, Texas	<i>Sophora secundiflora</i>	yes	10'	low	very low	yes	very high
Persimmon, Texas	<i>Diospyros texana</i>	yes	5'	low	very low	yes	high
Plum, Mexican	<i>Prunus mexicana</i>	yes	12'	low	low	yes	
Redbud, Mexican	<i>Cercis canadensis var. mexicana</i>	yes	10'	low	very low	yes	high
Redbud Texas	<i>Cercis canadensis var texensis</i>	yes	15'	low	low	yes	high
Silverthorn, thorny elaeagnus	<i>Elaeagnus pungens</i>	inv	8'	medium	low		high
Wax Myrtle	<i>Morella cerifera</i>	yes	10'	low	low-medium	yes	high

Shrubs							
Abelia	<i>Abelia grandiflora</i>	no	3'	medium	low-medium		
Abelia Glossy	<i>Abelia grandiflora</i>	no	3'	medium	low-medium		
Acuba	<i>Acuba japonica</i>	no	3'	medium	medium		high
Agarita	<i>Berberis trifoliata</i>	yes	4'	medium	very low	yes	very high
Baby Gem Boxwoods (not	<i>Buxus macrophylla</i> var <i>asiaticum</i>	no	1	low			
Beautyberry, American	<i>Callicarpa americana</i>	yes	3'	low	low-medium	yes	
Barberry Japanese	<i>Berberis thunbergii</i>	no	2'	low	low-medium		high
Bottlebrush, Dwarf	<i>Callistemon citrinus</i>	no	5'	medium	low		high
Butterfly Bush	<i>Buddleja davidii</i>	no	3'	low	medium	yes	
Butterfly Bush, Woolly	<i>Buddleja marrubiifolia</i>	yes	3	low	low	yes	high
Cotoneaster	<i>Cotoneaster species</i>	no	2'	medium	medium		high
Crepe Myrtle Dwarf (< 6' tall	<i>Lagerstroemia indica</i> varieties	no	3'	low	low-medium		
Dalea Black	<i>Dalea frutescens</i>	yes	2"	low	very low	yes	high
Elbowbush	<i>Forestiera pubescens</i>	yes	2'	low	very low	yes	
Esperanza, Yellow Bells	<i>Tecoma stans</i>	yes	3'	low	low-medium	yes	high
Fatsia	<i>Fatsia japonica</i>	no	5	medium	medium		
Flame Acanthus	<i>Anisacanthus quadrifidus</i> var	yes	2'	medium	very low	yes	very high
Flax Lily	<i>Dianella tasmanica</i>	no	1'	low	medium		
Germander Bush	<i>Teucrium fruticans</i>	no	2'	medium	low		high
Holly Dwarf Burford	<i>Ilex cornuta</i> var <i>Burfordii</i>	no	2'	medium	low		high
Holly, Dwarf Chinese	<i>Ilex cornuta</i> var <i>Rotunda</i>	no	2'	medium	low		high
Holly, Dwarf Yaupon	<i>Ilex vomitoria</i> var <i>Nana</i>	yes	2'	medium	low		
Indian Hawthorne	<i>Rhaphiolepis indica</i>	no	2	medium	medium		
Indian Hawthorne, Dwarf	<i>Rhaphiolepis indica</i> var <i>Pink</i>	no	1'	medium	medium		
Loropetalum Dwarf	<i>Loropetalum chinensis</i> var <i>Daruma</i>	no	3'	low	medium-high		
Rose, Knockout	<i>Rosa</i> Species Knock Out	no	2'	low	medium		
Rose, Livin' Easy	<i>Rosa</i> Species Livin' Easy	no	2'	low	medium		
Rose, Martha Gonzales	<i>Rosa</i> Species Martha Gonzales	no	2	low	medium		
Rosmary, Upright	<i>Rosmarinnus officinalis</i>	no	4'	high	medium		very high
Sage Silverado	<i>Leucophyllum frutescens</i> var	yes	3'	medium	low	yes	high
Sage Texas (Cenizo)	<i>Leucophyllum frutescens</i>	yes	3'	medium	low	yes	high
Thryalis, Golden Showers	<i>Galphimia glauca</i>	no	2'	low	low		very high
Viburnum, Sandankwa	<i>Viburnum suspensum</i>	no	5"	low	medium		high
Perennials							
Artemesia 'Powis Castle'	<i>Artemesia</i> 'Powis Castle	no	3'	low	v low		very high
Black-eyed Susan	<i>Rudbeckia fulgida</i> var. <i>sullivantii</i>	no	1'	low	low-medium	yes	very high
Bulbine	<i>Bulbine frutescens</i>	no	2'	low	very low		high
Calylophus, Square Bud	<i>Calylophus berlandieri</i>	yes	1	low	very low	yes	high

Perennials							
Cast Iron Plant	<i>Aspidistra elatior</i>	no	2'	low	low		high
Chile Pequin Chile Petin	<i>Capsicum annuum</i>	yes	2'	low	low	yes	high
Columbine Red	<i>Aquilegia canadensis</i>	yes	1'	low	medium	yes	high
Columbine, Yellow	<i>Aquilegia chrysantha var.</i>	yes	1'	low	medium	yes	high
Coreopsis	<i>Coreopsis lanceolata</i>	yes	1.5'	low	medium	yes	high
Cuphea, Bat Face	<i>Cuphea llavea</i>	no	0.5	low	low-medium		high
Cuphea, David Verity	<i>Cuphea David Verity</i>	no	1.5'	low	low-medium		
Daisy, Copper Canyon	<i>Tagetes lemmonii</i>	no	2	low	low		very high
Daisy Engelmann	<i>Engelmann peristenia</i>	yes	1'	low	medium	yes	
Turks Cap	<i>Malva viscus arboreus</i>	yes	2'	low	low	yes	
Fall Aster	<i>Aster oblongifolium</i>	yes	2.5'	low	low	yes	
Fern, Firecraker	<i>Russelia equisetiformis</i>	no	1.5'	low	low		high
Fern, River	<i>Thelypteris kunthii</i>	yes	1.5	low	medium-high	yes	
Firebush	<i>Hamelia patens</i>	no	2'	low	medium	yes	
Gaura	<i>Gaura lindheimerii</i>	yes	1.5'	low	low	yes	high
Gayfeather, Blazing Star	<i>Liatris mucronata</i>	yes	1'	low	very low	yes	
Hymenoxys, Four Nerve Daisy	<i>Tetranebris sacposa</i>	yes	0.5'	low	very low	yes	high
Indigo Spires	<i>Salvia Indigo Spires</i>	yes	3	low	low-medium	yes	high
Iris, Bearded	<i>Iris germanica</i>	no	1'	low	low		high
Iris Bicolor (African)	<i>Dietes bicolor</i>	no	1'	low	low		high
Lamb's Ear	<i>Stachys byzantina</i>	no	1'	low	low		very high
Lantana, Hybrid	<i>Lantana x hybrid</i>	yes	2'	low	low		high
Lantana, Texas	<i>Lantana urticoides</i>	yes	3'	low	very low	yes	high
Lion's Tail	<i>Leonotis leonurus</i>	no	3	low	low		high
Mexican Honeysuckle	<i>Justicia spicigera</i>	no	2'	low	low	yes	high
Obedient Plant Fall	<i>Physostegia virginiana</i>	yes	2'	low	medium	yes	
Plumbago	<i>Plumbago auriculata</i>	no	3'	low	low-medium	yes	high
Pride of Barbados	<i>Caesalpinia pulcherrima</i>	no	3'	medium	low		very high
Primrose, Missouri	<i>Oenothera missouriensis</i>	yes	1.5	low	low	yes	high
Purple Coneflower	<i>Echinacea purpurea</i>	yes	1'	low	low	yes	high
Rock Rose	<i>Pavonia lasiopetala</i>	yes	1.5'	low	low	yes	high
Ruelia Dwarf	<i>Ruellia bruttoniana</i>	no	1'	low	low	yes	high
Sage, Blue (Henry Duelberg)	<i>Salvia farinacea</i>	yes	1.5'	low	low	yes	
Sage, Cedar	<i>Salvia roemeriana</i>	yes	1'	low	very low	yes	very high
Sage, Cherry (Autumn sage)	<i>Salvia greggii</i>	yes	2	low	low	yes	very high
Sage, Jerusalem	<i>Phlomis fruiticosa</i>	no	2'	low	low		high
Sage, Majestic	<i>Salvia guaranitica</i>	no	2'	low	low		very high
Sage Mexican Bush	<i>Salvia leucantha</i>	no	2'	low	low	yes	very high

Perennials							
Sage, Tropical	<i>Salvia coccinea</i>	yes	1'	low	low		very high
Skeletonleaf Goldeneye	<i>Viguiera stenoloba</i>	yes	3'	low	very low	yes	high
Skullcap, Heartleaf	<i>Scutellaria ovata var bracteata</i>	yes	1	low	low	yes	
Skullcap, Pink	<i>Scutellaria suffrutescens</i>	no	1.5'	low	low		high
Society Garlic	<i>Tulbaghia violacea</i>	no	2'	low	low-medium		high
Spiderwort	<i>Tradescantia species</i>	yes	1'	low	low	yes	
Texas Betony	<i>Stachys coccinea</i>	yes	2'	low	low	yes	very high
Verbena	<i>Verbena species</i>	yes	1	low	low	yes	high
Winecup, Perennial	<i>Callirhoe involucrata</i>	yes	2'	low	low	yes	high
Yarrow	<i>Achillea species</i>	no	1.5'	low	medium	yes	very high
Zexmenia	<i>Wedelia texana</i>	yes	2'	low	low	yes	high
Yuccas/Agaves/Succulents/Cacti/Sotols							
Agave, Parry's	<i>Agave parryi</i>	yes	1	very low	very low	yes	high
Agave, Queen Victoria	<i>Agave victoriae-reginae</i>	yes	1'	very low	very low		
Agave Squid	<i>Agave bracteosa</i>	no	1'	very low	very low	yes	high
Basket Grass, Sacahuista	<i>Nolina texana</i>	yes	2'	very low	very low	yes	very high
Cactus, Prickly Pear	<i>Opuntia species</i>	yes	2'	very low	low	yes	high
Texas Sotol	<i>Dasyllirion texanum</i>	yes	2	very low	low	yes	high
Yucca, Gaint	<i>Hesperaloe funiera</i>	no	2'	low	very low	yes	
Yucca Paleleaf	<i>Yucca pallida</i>	yes	1'	very low	very low	yes	high
Yucca Red	<i>Hesperaloe parviflora</i>	yes	2'	very low	very low	yes	high
Yucca, Softleaf	<i>Yucca recurvifolia</i>	no	2	low	very low	yes	high
Yucca, Twistleaf	<i>Yucca rupicola</i>	yes	2	low	very low	yes	very high
Groundcover							
Aztec Grass	<i>Ophiopogon intermedius</i>	no	1'	very low	medium		
Dalea Gregg	<i>Dalea greggii</i>	yes	2'	low	low	yes	high
Germander Creeping	<i>Teucrium cossonii</i>	no	1'	low	low		high
Jasmine, Asian	<i>Trachelospermum aiaticum</i>	no	2'	low	medium		
Leadwort Plumbago	<i>Ceratostigma plumbaginoides</i>	no	2'	low	low		high
Liriope	<i>Liriope muscari</i>	no	1	low	medium		
Monkey Grass	<i>Ophiopogon japonicus</i>	no	0.5'	low	medium		high
Mountain Pea	<i>Orbexilum species</i>	no	2'	low	low		
Purple Heart	<i>Setcreasea pallida</i>	no	1.5'	low	low		
Rosemary, Trailing	<i>Rosmarinus officinalis var</i>	no	3'	high	low		high
Santolina (Lavender Cotton)	<i>Santolina chamaecyparissus</i>	no	2	low	very low		very high
Sedge, Berkley	<i>Carex tumtlicola</i>	no	0.5'	low	low		high



## APPENDIX F – NO-PAPERWORK LIST

**A home owner is responsible for meeting all DG requirements for the modifications listed even though an application and approval from the MC is not required.**

#	Item	Article #
1	Cellular Telephone booster/repeater antenna.	<b>6.4</b>
2	FM radio and amateur radio antennas. The owners' Amateur Radio Operator License must be on file with the Community Standards Department.	<b>6.4 &amp; 6.5</b>
3	HDTV and similar antennas for television/internet.	<b>6.4</b>
4	Adding plants and shrubs in an existing planting bed.	<b>4.4</b>
5	Bird Baths/Bird Houses/Bird Feeders in rear yard that are 6-feet tall or less.	<b>5.4.b</b>
6	Bird Baths/Bird Houses/Bird Feeders hanging from a tree in the front yard. Limit 2 items.	<b>5.10.3.b</b>
7	Bird Baths/Bird Houses/Bird Feeders in the front yard up to 6-feet tall and within 2-feet of the house foundation. Limit 1 item.	<b>5.4.a</b>
8	Construction/Landscaping Debris Boxes ("Dumpsters")	<b>6.12</b>
9	Edging for existing planting beds and tree wells.	<b>4.4.g &amp; 4.16.d</b>
10	House entry door replacement: a) Fits in the existing door opening and the same style and color as the original. b) Does not contain any colored glass. Does not apply to Cottages.	<b>3.10</b>
11	Exterior wall art and ornamentation.	<b>5.10</b>
12	Flags and flag mounts (except flags illuminated for night time display) mounted in one of the preferred locations: a) Display of the US Flag, any US State Flag or any US Armed Service Flag. b) Display of a university, college or professional sports team flags. c) Flag Mounts attached to a building. d) Flags or banners celebrating holidays listed in Appendix C. e) Seasonal flags, pendants or banners. f) "Blue Lives Matter" flags.	<b>5.9</b>
13	Flower boxes on decorative concrete fences or under garage windows of cottages.	<b>14.9.b.5</b>
14	Artificial or natural flowers, plants, and trees placed on a front or rear porch/patio.	<b>5.6</b>
15	Garden hose hanger.	<b>5.3</b>
16	Gutter guards that match the existing trim paint color.	<b>3.15.c.6</b>
17	Handrails and safety guard rails.	<b>10.1</b>
18	Holiday Decorations.	<b>5.5 &amp; Appendix C</b>
19	Knox Box® Installation.	<b>3.9</b>

#	Item	Article #
20	Flower pots, decorative objects, and other artifacts in LMH house beds or on porches/patios.	<b>14.9</b>
21	Wall-mounted light fixtures conforming to the referenced articles and: a) Must be fully shielded. b) An unshielded fixture that is not larger than the developer-installed fixtures. Does not apply to Cottages.	<b>7.1, 7.2, 7.3 &amp; 7.4</b>
22	Lightning Arrestors (Lightning Rods).	<b>6.8</b>
23	Developer-installed mailboxes, secure locking mailboxes, and plastic/metal bird deterrent spikes.	<b>5.7.1 &amp; 5.7.2</b>
24	Mulching Material (Seasonal Placement). Not applicable to LMH homes.	<b>4.2 &amp; 4.4</b>
25	Painting a home's exterior without changing the color scheme. Does not apply to Cottages.	<b>3.15.b</b>
26	Walkway, pathway or driveway recoating without changing the color scheme.	<b>3.16</b>
27	Pet door in a side entry door (not a golf cart door) or rear door within a fenced area.	<b>3.8.1</b>
28	Small Animal fencing.	<b>9.1.n</b>
29	Potted plants or free-standing objects on the driveway.	<b>5.10.2</b>
30	Replacement of individual plants (in-ground or potted) of the same or similar type or size that does not alter the approved landscape plan. Not applicable to LMH homes.	<b>4.4</b>
31	Re-sodding a lawn with an approved grass. Saint Augustine and common Bermuda are prohibited.	<b>4.11</b>
32	Roof patching, partial replacement or full replacement with a shingle that has a warranty that is equivalent to, or better than, the warranty of the shingles being replaced. Must use an approved shingle color. Includes ridge vents.	<b>3.3.1 &amp; 3.3.4.f</b>
33	Safety handrails.	<b>10.1 &amp; 10.2</b>
34	Satellite Antenna. Requirements for a "no-paperwork" installation are: a) Meet provisions of List 6-1 & 6-2. b) All exposed wiring must be routed at right angles and securely fastened to the home.	<b>6.3</b>
35	Skylights, tubular variety that do not contain internal lighting and attic fans. A CoG permit required.	<b>6.2.1 &amp; 6.2.2</b>
36	Solar-powered pathway lights. Lights meeting the following requirements and conforming to the referenced article may be installed: a) Along the pathway from the front entry to the driveway and/or to the street. b) Along one side of the driveway continuing to the front entry of the house. c) No taller than 3-feet from the developer-finished grade. d) Must be at least 4-feet to 6-feet from any ground-mounted light. Lights may be closer at steps, elevation changes, and changes in pathway direction. e) Light must be directed downward and the fixtures must be fully shielded. f) Light fixtures emitting anything other than white light are prohibited. Color lights are prohibited. g) Light fixtures with non-reflective finishes must be used. Polished light fixtures are prohibited. Does not apply to Cottages.	<b>7.4 &amp; 7.5</b>

#	Item	Article #
37	Window solar screens	<b>12.1.2</b>
38	Statues, ornaments and other accessory features not exceeding 3-feet in the front yard.	<b>5.10.1</b>
39	Statues, ornaments and other accessory features not exceeding 5-feet in rear and side yards.	<b>5.10.5</b>
40	Swings, gliders, and hammocks.	<b>5.10.5.b</b>
41	Tree trimming - Trimming of that portion of any tree canopy that is above the owner's property.	<b>4.21 &amp; 6.6.2</b>
42	Tree planting - Trees meeting the following requirements and conforming to the provisions of referenced article: a) Tree must be one of the trees listed in Appendix D. b) Tree trunk must be at least 10-feet from any property line c) Tree trunk on golf course lots must be at least 20-feet from the rear property line. d) Tree trunks must be at least 20-feet from any other tree on the property. Does not apply to LMH house or lots with developer-installed retaining walls.	<b>4.22 &amp; APPENDIX D</b>
43	Tree removal – any tree that is not on the listed in Appendix D that is less than 19 inches in circumference when measured 12-inches from the ground, may be removed.	<b>4.22.d &amp; APPENDIX D</b>
44	Ground-mounted and roof-mounted weather station	<b>6.9.1 &amp; 6.9.2</b>
45	Self-contained water fountains less than 3-feet tall in the front or 5-feet tall in the rear yard.	<b>5.2</b>
46	Wild Animal Protection fencing. Does not apply to LMH homes.	<b>4.24</b>
47	Window or Door (House or Garage) Replacement for Emergency Repair. An application required after the repair is completed.	<b>3.11</b>
48	Garage door key pads, door peepholes and video door bells.	<b>3.12</b>
49	Repair or reconstruction of a house and associated landscaping consistent with original construction within 12-months.	<b>3.7.b.1</b>
50	LMH Homes: Adding annual bedding plants to planting beds at the home owner's expense.	<b>14.6</b>



### APPENDIX G – PROHIBITED ITEMS & STRUCTURE LIST

The items presented in this list are prohibited. It is not inclusive and does not name all of the items that are prohibited.

#	Item	Article #
1	Accessory buildings, including gazebos, storage buildings, guest houses and greenhouses at other than custom homes.	<b>3.5</b>
2	Alteration of natural lawn color through the application of any dye, paint or agent other than feeds and fertilizers appropriate for such use.	<b>4.12</b>
3	Any permanent or temporary devices not specifically allowed in the DG or GD. Such devices may include, but are not limited to: gas or electric lampposts, basketball hoops, purple martin houses, bat houses and mailbox bird deterrents like pinwheels and owl figures.	_____
4	Artificial Flowers or Foliage anyplace other than a porch or patio and in courtyard areas.	<b>5.6</b>
5	Boundary marking, except with approved fencing, or as specifically provided.	<b>4.20</b>
6	Clotheslines or clothes poles and similar items.	_____
7	Concrete block, concrete masonry unit, railroad ties or any lumber.	<b>4.18.c.4</b>
8	Combined use of both mesh materials and wildlife netting.	_____
9	Decorative fencing.	<b>9.3</b>
10	Detached garages.	<b>3.5</b>
11	The display of national flags of countries listed as State Sponsors of Terrorism by the US Department of State.	<b>5.9.h.2</b>
12	Electric or electrified fences.	_____
13	Parallel fences.	<b>9.1.i</b>
14	Fencing configurations which create a “dog run” or the appearance of one.	<b>9.1.0</b>
15	Fencing with wood or wood-like composition material.	<b>9.1</b>
16	Fences with scrolls, patterns or straight elements that are not at right angles to each other.	<b>9.1.d</b>
17	Fences with spikes or other adornment above the top rail.	<b>9.1.h &amp; 9.1.j</b>
18	St. Augustine or Common Bermuda turf grasses.	<b>4.11</b>
19	Hedges or hedge rows composed of plant material.	<b>4.14</b>
20	Installation of anything over 3-feet tall in the rear 20-feet of a golf course lot.	<b>5.4.c</b>
21	Polished or highly reflective lighting fixtures.	<b>7.4.i</b>
22	Lighting that constitutes a nuisance and/or hazard to any resident.	<b>7.3</b>
23	Mailbox replacements other than the developer-installed type. Custom Homes are exempt.	<b>5.7.1</b>

#	Item	Article #
24	Inorganic mulching material, ground or pulverized rubber mulch, dyed mulches and highly reflective rock of any dimension.	<b>4.7.1.c</b>
25	Pet doors in roll up garage door.	<b>3.8.1.b</b>
26	Placement and storage of construction material and/or equipment on the street without permitting by the appropriate CoG agency.	<b>2.1, 3.6.3 &amp; 3.7</b>
27	Placement of objects on the driveway or around the storm drains.	<b>5.10.2</b>
28	Roofing any patio enclosure with transparent material (i.e. glass, Lexan).	<b>11.3.b.1</b>
29	Screened enclosure of the front entry area of the house.	<b>11.1.a</b>
30	White screening structures, trellises and arbors.	<b>4.13.d &amp; 12.3.2.c</b>
31	Sheds, dog houses or any other similar free-standing structure.	<b>3.5</b>
32	Tents, tenting and fabric shades other than approved permanent awnings.	_____
33	Trees or tall plants that are taller than 3-feet, within the "sight triangle" of a corner lot or tree branches lower than 8-feet that over-hang into the "sight triangle" of a corner lot.	<b>4.17</b>
34	Trellis/arbor attachment to a developer-installed fence or wall.	<b>12.3.3.a.11 &amp; 12.3.3.b.10</b>
35	The storage of equipment, tools or materials anywhere on a lot.	<b>12.3.1.e</b>
36	Window air conditioning units and fans.	<b>6.1.c</b>
37	Exterior security system sirens.	<b>6.15</b>
38	Arbors in front or side yards.	<b>12.3.3.b.8</b>
39	Ground covering and landscape materiel used to spell names, depict states, or slogans, etc.	<b>4.7.3</b>
40	Nighttime illumination of college, university flags or professional sport team flags.	<b>5.9.e.9</b>
41	Lampposts and polished metal fixtures.	<b>5.8 &amp; 7.4.i</b>
42	The use of plywood, Masonite or other similar materials as siding.	<b>3.2.d</b>
43	Roofing materials other than asphalt shingles.	<b>3.3.5</b>
44	Permanent tree-mounted lights.	<b>7.4.h</b>
45	Reflective house numbers painted on street curbs.	_____
46	Driveways, sidewalks, etc. cannot be coated in asphalt or loose materials.	<b>3.15.e</b>
47	Using approved screening structures to store trash containers, tools, etc.	<b>4.13.g</b>
48	Solid plastic landscaping sheeting as a weed barrier.	<b>4.19.a</b>
49	Streamers or reflective material in vegetable/herb gardens.	<b>4.18.f.3</b>
50	Streamers or reflective material on mailboxes.	_____